

HYDRAULIC FILTRATION PRODUCTS

SPIN-ON FILTERS



PASSION TO PERFORM





A WORLDWIDE LEADER IN THE FIELD OF HYDRAULIC FILTRATION EQUIPMENT.

Our company started life in 1964, when Bruno Pasotto decided to attempt to cater for the requests of a market still to be fully explored, with the study, design, development, production and marketing of a vast range of filters for hydraulic equipment, capable of satisfying the needs of manufacturers in all sectors. The quality of our products, our extreme competitiveness compared with major international producers and our constant activities of research, design and development has made us a worldwide leader in the field of hydraulic circuit filtering. Present for over 50 years in the market, we have played a truly decisive role in defining our sector, and by now we are a group capable of controlling our entire chain of production, monitoring all manufacturing processes to guarantee superior quality standards and to provide concrete solutions for the rapidly evolving needs of customers and the market.

MARKET LEADER



Our work is based on a skillful interaction between advanced technology and fine workmanship, **customizing products according to specific market requests**, focusing strongly on innovation and quality, and following every step in the manufacturing of both standard and special products, fully respecting customer expectations.



Our customer-oriented philosophy, which enables us to satisfy all customer requests **rapidly and with personalized products**, makes us a **dynamic and flexible enterprise**. The possibility of constantly controlling and monitoring the entire production process is essential to allow us to guarantee the quality of our products.

WORLDWIDE PRESENCE

Our foreign Branches enable us to offer a diversified range of products that allow us to successfully face the aggressive challenge of international competition, and also to maintain a stable presence at a local level.

The Group boasts **8** business branches



TECHNOLOGY

Our constant **quest for excellence in quality and technological innovation** allows us to offer only the best solutions and services for applications in many fields, including general industry, test rigs, lubrication, heavy engineering, renewable energies, naval engineering, offshore engineering, aviation systems, emerging technologies and mobile plant (i.e. tractors, excavators, concrete pumps, platforms).



AND PRODUCTION

Our high level of technological expertise means **we can rely entirely on our own resources, without resorting to external providers.** This in turn enables us to satisfy a growing number of customer requests, also exploiting our constantly updated range of machines and equipment, featuring **fully-automated workstations** capable of **24-hour production.**

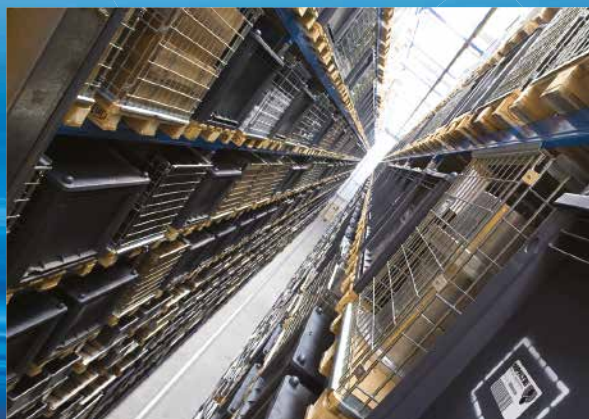



SUCTION FILTERS

Flow rates
up to 875 l/min

- Mounting:
- Tank immersed
 - In-Line
 - In tank with shut off valve
 - In tank with flooded suction

RETURN FILTERS

Flow rates
up to 3000 l/min

- Pressure
up to 20 bar
- Mounting:
- In-Line
 - Tank top
 - In single and duplex designs

RETURN / SUCTION FILTERS

Flow rates
up to 300 l/min

- Pressure
up to 80 bar
- Mounting:
- In-Line
 - Tank top

SPIN-ON FILTERS

Flow rates
up to 365 l/min

- Pressure
up to 35 bar
- Mounting:
- In-Line
 - Tank top

LOW & MEDIUM PRESSURE FILTERS

Flow rates
up to 3000 l/min

- Pressure
up to 80 bar
- Mounting:
- In-Line
 - Parallel manifold version
 - In single and duplex designs

HIGH PRESSURE FILTERS

Flow rates
up to 750 l/min

- Pressure from 110 bar
up to 560 bar
- Mounting:
- In-Line
 - Manifold
 - In single and duplex designs

PRODUCT RANGE

MP Filtri can offer a vast and articulated range of products for the global market, suitable for all industrial sectors using hydraulic equipment.

This includes filters (suction, return, return/suction, spin-on, pressure, stainless steel pressure) and structural components (motor/pump bell-housings, transmission couplings, damping rings, foot brackets, aluminium tanks, cleaning covers).

We can provide all the skills and solutions required by the modern hydraulics industry to monitor contamination levels and other fluid conditions.

Mobile filtration units and a full range of accessories allow us to supply everything necessary for a complete service in the hydraulic circuits.



STAINLESS STEEL HIGH PRESSURE FILTERS

Flow rates up to 150 l/min
Pressure from 320 bar
up to 1000 bar

Mounting:

- In-Line
- Manifold
- In single and duplex designs

CONTAMINATION MONITORING PRODUCTS

- Online, in-line particle counters
- Off-line Bottle sampling products
- Fully calibrated using relevant ISO standards
- A wide range of variants to support fluid types and communication protocols

MOBILE FILTRATION UNITS

Flow rates from 15 l/min
up to 200 l/min

POWER TRANSMISSION PRODUCTS

- Aluminium bell-housings for motors from 0.12 kW to 400 kW
- Couplings in Aluminium Cast Iron - Steel
- Damping rings
- Foot bracket
- Aluminium tanks
- Cleaning covers

ACCESSORIES

- Oil filler and air breather plugs
- Optical and electrical level gauges
- Pressure gauge valve selectors
- Pipe fixing brackets
- Pressure gauges

HYDRAULIC FILTRATION PRODUCTS

1	page	INTRODUCTION
1		COMPANY
6		PRODUCT RANGE
11		CONTAMINATION MANAGEMENT
22		FILTER SIZING
24		CORRECTIVE FACTOR

28	page	SUCTION FILTERS			up to Q_{max}
					l/min gpm
31	STR & MPA - MPM	Submerged suction filter, with bypass or magnetic column			875 231
39	SF2 250 - 350	Semi-submerged positive head suction filter, low flow rate			160 42
47	SF2 500	Semi-submerged positive head suction filter, high flow rate			800 211
57	CLOGGING INDICATORS				

60	page	RETURN FILTERS		up to P_{max}	up to Q_{max}
			bar	psi	l/min gpm
63	MPFX	Tank top semi-immersed filter, standard filter element disassembly	8	116	750 198
91	MPLX	Tank top semi-immersed filter, standard filter element disassembly	10	145	1800 476
99	MPTX	Tank top semi-immersed filter, easy filter element disassembly	8	116	300 79
117	MFBX	Bowl assembly	8	116	500 132
125	MPF	Tank top semi-immersed filter, standard filter element disassembly	8	116	750 198
153	MPT	Tank top semi-immersed filter, easy filter element disassembly	8	116	300 79
171	MFB	Bowl assembly	8	116	500 132
179	MPH	Tank top semi-immersed filter, standard filter element disassembly	10	145	3000 793
203	MPI	Tank top semi-immersed filter, standard filter element disassembly	10	145	3000 793
215	FRI	Tank top semi-immersed filter, easy filter element disassembly, it can be used also as in-line filter	20	290	1500 396
231	RF2	Semi-immersed under-head filter, easy filter element disassembly	20	290	350 92
238	CLOGGING INDICATORS				
248	ACCESSORIES				

250	page	RETURN / SUCTION FILTERS		up to P_{max}	up to Q_{max}
			bar	psi	l/min gpm
253	MRSX	Unique TANK TOP filter for mobile machinery, with combined filtration on return and suction to the inlet at the hydrostatic transmissions in closed circuit	10	145	300 79
265	LMP 124 MULTIPORT	Unique IN-LINE filter for mobile machinery, with combined filtration on return and suction to the inlet at the hydrostatic transmissions in closed circuit	80	1160	200 53
273	CLOGGING INDICATORS				

286	page	SPIN-ON FILTERS		up to P_{max}	up to Q_{max}
			bar	psi	l/min gpm
289	MPS	Low pressure filter, available with single cartridge (CS) for in-line or flange mounting or with two cartridge on the same axis on the opposite sides	12	174	365 96
305	MSH	In-line low and medium pressure filter available with single cartridge (CH)	35	508	195 52
311	CLOGGING INDICATORS				

page	LOW & MEDIUM PRESSURE FILTERS	up to P _{max}		up to Q _{max}		
		bar	psi	l/min	gpm	
325	LMP 110 - 120 - 123 MULTIPORT	In-line filter with Multiport design for multiple choice connection	80	1160	200	53
341	LMP 210 - 211	In-line low & medium pressure filter, low flow rate	60	870	330	87
351	LMP 400 - 401 & 430 - 431	In-line low & medium pressure filter, high flow rate	60	870	740	195
363	LMP 950 - 951	In-line filter, available with 2 and up to 6 different heads	30	435	2400	634
371	LMP 952 - 953 - 954	In-line low pressure filter specifically designed to be mounted in series	25	363	3000	793
383	LMD 211	In-line duplex medium pressure filter	60	870	330	87
391	LMD 400 - 401 & 431	In-line duplex low pressure filter	16	232	590	156
407	LMD 951	In-line duplex filter, available with 2 up to 6 different heads	16	232	1200	317
415	Filter elements designed according to DIN 24550					
417	LDP - LDD	In-line and duplex medium pressure filter	60	870	330	87
427	LMP 900 - 901	In-line low pressure filter	30	435	2000	528
435	LMP 902 - 903	In-line filter specifically designed to be mounted in series	20	290	3000	793
444	CLOGGING INDICATORS					

page	HIGH PRESSURE FILTERS	up to P _{max}		up to Q _{max}		
		bar	psi	l/min	gpm	
453	FMP 039	Filter high pressure, low flow rate applications	110	1595	80	21
461	FMP	Filter high pressure, high flow rate applications	320	4641	475	125
473	FHP	Typical high pressure filter for mobile applications, high flow rate	420	6092	750	198
489	FMM	Typical high pressure filter for mobile applications, low flow rate	420	6092	250	66
499	FHA 051	Filter optimized for use in high pressure operating systems, low flow rate	560	8122	140	37
507	FHM	High pressure filter with intermediate manifold construction	320	4641	450	119
525	FHB	High pressure for block mounting	320	4641	485	128
539	FHF 325	In-line manifold top mounting	350	5076	500	132
549	FHD	In-line duplex high pressure filter	350	5076	345	91
562	CLOGGING INDICATORS					

page	STAINLESS STEEL HIGH PRESSURE FILTERS	up to P _{max}		up to Q _{max}		
		bar	psi	l/min	gpm	
573	FZP	In-line pressure filter with threaded mount	420	6092	150	40
583	FZH	In-line pressure filter with threaded mount for higher pressure	700	10153	50	13
593	FZX	In-line pressure filter with threaded mount up to 1000 bar	1000	14504	10	3
601	FZM	Manifold top mounting	320	4641	70	18
609	FZB	Manifold side mounting	320	4641	75	20
617	FZD	Duplex pressure filter for continuous operation requirements	350	5076	90	24
627	CLOGGING INDICATORS					

page	CLOGGING INDICATORS
635	QUICK REFERENCE GUIDE



CONTAMINATION MANAGEMENT

INDEX

	Page
① HYDRAULIC FLUIDS	12
② FLUIDS CONTAMINATION	12
③ EFFECTS OF CONTAMINATION ON HYDRAULIC COMPONENTS	12
④ MEASURING THE SOLID CONTAMINATION LEVEL	13
⑤ FILTRATION TECHNOLOGIES	16
⑥ RECOMMENDED CONTAMINATION CLASSES	17
⑦ TYPES OF FILTERS	17
⑧ FILTER SIZING PARAMETERS	18
⑨ APPLICABLE STANDARDS FOR FILTER DEVELOPMENT	18
⑩ WATER IN HYDRAULIC AND LUBRICATING FLUIDS	19

① HYDRAULIC FLUIDS

The fluid is the vector that transmits power, energy within an oleodynamic circuit. In addition to transmitting energy through the circuit, it also performs additional functions such as lubrication, protection and cooling of the surfaces.

The classification of fluids used in hydraulic systems is coded in many regulatory references, different Standards.

The most popular classification criterion divides them into the following families:

- MINERAL OILS

Commonly used oil deriving fluids.

- FIRE RESISTANT FLUIDS

Fluids with intrinsic characteristics of incombustibility or high flash point.

- SYNTHETIC FLUIDS

Modified chemical products to obtain specific optimized features.

- ECOLOGICAL FLUIDS

Synthetic or vegetable origin fluids with high biodegradability characteristics.

The choice of fluid for an hydraulic system must take into account several parameters.

These parameters can adversely affect the performance of an hydraulic system, causing delay in the controls, pump cavitation, excessive absorption, excessive temperature rise, efficiency reduction, increased drainage, wear, jam/block or air intake in the plant.

The main properties that characterize hydraulic fluids and affect their choice are:

- DYNAMIC VISCOSITY

It identifies the fluid's resistance to sliding due to the impact of the particles forming it.

- CINEMATIC VISCOSITY

It is a widespread formal dimension in the hydraulic field.

It is calculated with the ratio between the dynamic viscosity and the fluid density.

Cinematic viscosity varies with temperature and pressure variations.

- VISCOSITY INDEX

This value expresses the ability of a fluid to maintain viscosity when the temperature changes.

A high viscosity index indicates the fluid's ability to limit viscosity variations by varying the temperature.

- FILTERABILITY INDEX

It is the value that indicates the ability of a fluid to cross the filter materials. A low filterability index could cause premature clogging of the filter material.

- WORKING TEMPERATURE

Working temperature affects the fundamental characteristics of the fluid. As already seen, some fluid characteristics, such as cinematic viscosity, vary with the temperature variation.

When choosing a hydraulic oil, must therefore be taken into account of the environmental conditions in which the machine will operate.

- COMPRESSIBILITY MODULE

Every fluid subjected to a pressure contracts, increasing its density.

The compressibility module identifies the increase in pressure required to cause a corresponding increase in density.

- HYDROLYTIC STABILITY

It is the characteristic that prevents galvanic pairs that can cause wear in the plant/system.

- ANTIOXIDANT STABILITY AND WEAR PROTECTION

These features translate into the capacity of a hydraulic oil to avoid corrosion of metal elements inside the system.

- HEAT TRANSFER CAPACITY

It is the characteristic that indicates the capacity of hydraulic oil to exchange heat with the surfaces and then cool them.

② FLUID CONTAMINATION

Whatever the nature and properties of fluids, they are inevitably subject to contamination. Fluid contamination can have two origins:

- INITIAL CONTAMINATION

Caused by the introduction of contaminated fluid into the circuit, or by incorrect storage, transport or transfer operations.

- PROGRESSIVE CONTAMINATION

Caused by factors related to the operation of the system, such as metal surface wear, sealing wear, oxidation or degradation of the fluid, the introduction of contaminants during maintenance, corrosion due to chemical or electrochemical action between fluid and components, cavitation. The contamination of hydraulic systems can be of different nature:

- SOLID CONTAMINATION

For example rust, slag, metal particles, fibers, rubber particles, paint particles or additives

- LIQUID CONTAMINATION

For example, the presence of water due to condensation or external infiltration or acids

- GASEOUS CONTAMINATION

For example, the presence of air due to inadequate oil level in the tank, drainage in suction ducts, incorrect sizing of tubes or tanks.

③ EFFECTS OF CONTAMINATION ON HYDRAULIC COMPONENTS

Solid contamination is recognized as the main cause of malfunction, failure and early degradation in hydraulic systems. It is impossible to delete it completely, but it can be effectively controlled by appropriate devices.

CONTAMINATION IN PRESENCE OF LARGE TOLERANCES



CONTAMINATION IN PRESENCE OF NARROW TOLERANCES



Solid contamination mainly causes surface damage and component wear.

- ABRASION OF SURFACES

Cause of leakage through mechanical seals, reduction of system performance, failures.

- SURFACE EROSION
Cause of leakage through mechanical seals, reduction of system performance, variation in adjustment of control components, failures.
- ADHESION OF MOVING PARTS
Cause of failure due to lack of lubrication.
- DAMAGES DUE TO FATIGUE
Cause of breakdowns and components breakdown stem performance, failures.

- MODIFICATION OF FLUID PROPERTIES (COMPRESSIBILITY MODULE, DENSITY, VISCOSITY)
Cause of system's reduction of efficiency and of control.
It is easy to understand how a system without proper contamination management is subject to higher costs than a system that is provided.
- MAINTENANCE
Maintenance activities, spare parts, machine stop costs
- ENERGY AND EFFICIENCY
Efficiency and performance reduction due to friction, drainage, cavitation.

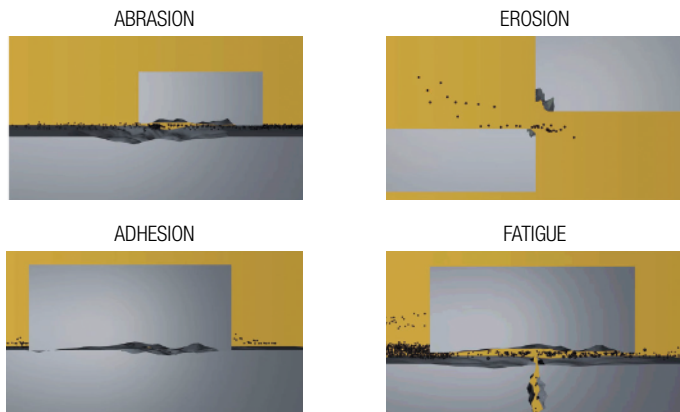

Liquid contamination mainly results in decay of lubrication performance and protection of fluid surfaces.

DISSOLVED WATER

- INCREASING FLUID ACIDITY
Cause of surface corrosion and premature fluid oxidation
- GALVANIC COUPLE AT HIGH TEMPERATURES
Cause of corrosion

FREE WATER - ADDITIONAL EFFECTS

- DECAY OF LUBRICANT PERFORMANCE
Cause of rust and sludge formation, metal corrosion and increased solid contamination
- BATTERY COLONY CREATION
Cause of worsening in the filterability feature
- ICE CREATION AT LOW TEMPERATURES
Cause damage to the surface
- ADDITIVE DEPLETION
Free water retains polar additives

Gaseous contamination mainly results in decay of system performance.

- CUSHION SUSPENSION
Cause of increased noise and cavitation.
- FLUID OXIDATION
Cause of corrosion acceleration of metal parts.

4 MEASURING THE SOLID CONTAMINATION LEVEL

The level of contamination of a system identifies the amount of contaminant contained in a fluid.

This parameter refers to a unit volume of fluid.

The level of contamination may be different at different points in the system. From the information in the previous paragraphs it is also apparent that the level of contamination is heavily influenced by the working conditions of the system, by its working years and by the environmental conditions.

What is the size of the contaminating particles that we must handle in our hydraulic circuit?

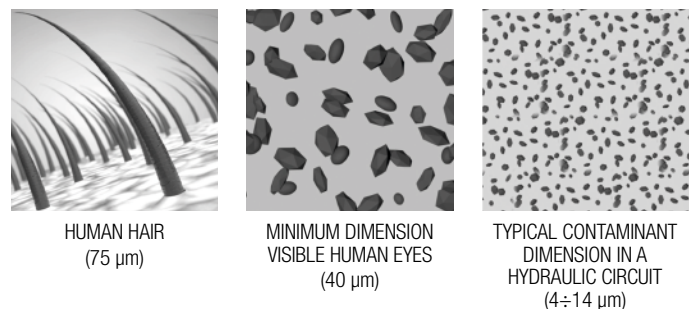

Contamination level analysis is significant only if performed with a uniform and repeatable method, conducted with standard test methods and suitably calibrated equipment.

To this end, ISO has issued a set of standards that allow tests to be conducted and express the measured values in the following ways.

- GRAVIMETRIC LEVEL - ISO 4405

The level of contamination is defined by checking the weight of particles collected by a laboratory membrane. The membrane must be cleaned, dried and desiccated, with fluid and conditions defined by the Standard.

The volume of fluid is filtered through the membrane by using a suitable suction system. The weight of the contaminant is determined by checking the weight of the membrane before and after the fluid filtration.

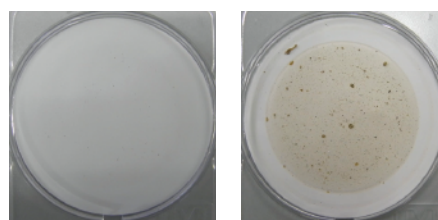

CONTAMINATION MANAGEMENT

- CUMULATIVE DISTRIBUTION OF THE PARTICLES SIZE - ISO 4406

The level of contamination is defined by counting the number of particles of certain dimensions per unit of volume of fluid. Measurement is performed by Automatic Particle Counters (APC).

Following the count, the contamination classes are determined, corresponding to the number of particles detected in the unit of fluid.

The most common classification methods follow ISO 4406 and SAE AS 4059 (Aerospace Sector) regulations.

NAS 1638 is still used although obsolete.

Classification example according to ISO 4406

The code refers to the number of particles of the same size or greater than 4, 6 or 14 μm in a 1 ml fluid.

Class	Number of particles per ml	
	Over	Up to
28	1 300 000	2 500 000
27	640 000	1 300 000
26	320 000	640 000
25	160 000	320 000
24	80 000	160 000
23	40 000	80 000
22	20 000	40 000
21	10 000	20 000
20	5 000	10 000
19	2 500	5 000
18	1 300	2 500
17	640	1 300
16	320	640
15	160	320
14	80	160
13	40	80
12	20	40
11	10	20
10	5	10
9	2.5	5
8	1.3	2.5
7	0.64	1.3
6	0.32	0.64
5	0.16	0.32
4	0.08	0.16
3	0.04	0.08
2	0.02	0.04
1	0.01	0.02
0	0	0.01

- > 4 $\mu\text{m}_{(c)}$ = 350 particles
 - > 6 $\mu\text{m}_{(c)}$ = 100 particles
 - > 14 $\mu\text{m}_{(c)}$ = 25 particles
- 16 / 14 / 12

ISO 4406:2017 Cleanliness Code System

Microscope counting examines the particles differently to APCs and the code is given with two scale numbers only.

These are at 5 μm and 15 μm equivalent to the 6 $\mu\text{m}_{(c)}$ and 14 $\mu\text{m}_{(c)}$ of APCs.

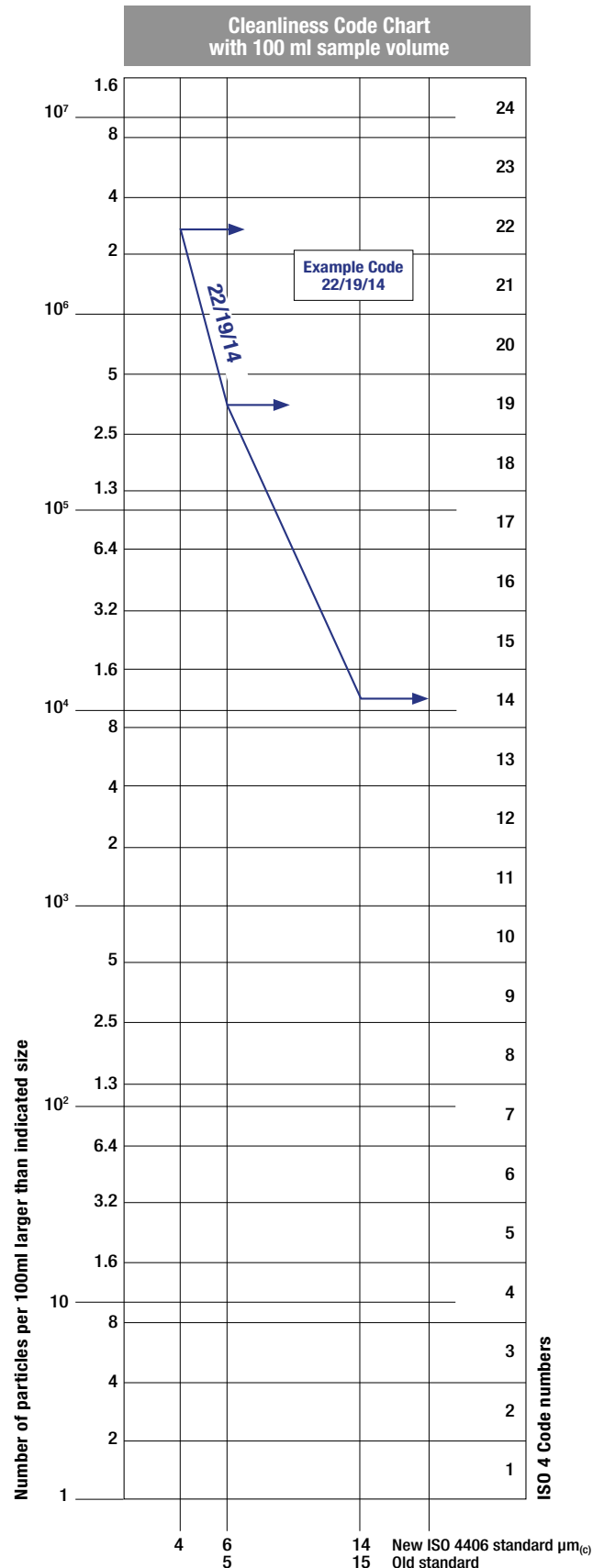

- CUMULATIVE DISTRIBUTION OF THE PARTICLES SIZE - SAE AS 4059-1 and SAE AS 4059-2

Classification example according to SAE AS 4059-1 and SAE AS 4059-2

The code, prepared for the aerospace industry, is based on the size, quantity, and particle spacing in a 100 ml fluid sample. The contamination classes are defined by numeric codes, the size of the contaminant is identified by letters (A-F).

It can be made a differential measurement (Table 1) or a cumulative measurement (Table 2)

Table 1 - Class for differential measurement

Class	Dimension of contaminant				
	6÷14 µm _(c)	14÷21 µm _(c)	21÷38 µm _(c)	38÷70 µm _(c)	>70 µm _(c)
00	125	22	4	1	0
0	250	44	8	2	0
1	500	89	16	3	1
2	1 000	178	32	6	1
3	2 000	356	63	11	2
4	4 000	712	126	22	4
5	8 000	1 425	253	45	8
6	16 000	2 850	506	90	16
7	32 000	5 700	1 012	180	32
8	64 000	11 400	2 025	360	64
9	128 000	22 800	4 050	720	128
10	256 000	45 600	8 100	1 440	256
11	512 000	91 200	16 200	2 880	512
12	1 024 000	182 400	32 400	5 760	1 024

6÷14 µm _(c) = 15 000 particles
14÷21 µm _(c) = 2 200 particles
21÷38 µm _(c) = 200 particles
38÷70 µm _(c) = 35 particles
> 70 µm _(c) = 3 particles
Class 6

Table 2 - Class for cumulative measurement

Class	Dimension of contaminant					
	>4 µm _(c) A	>6 µm _(c) B	>14 µm _(c) C	>21 µm _(c) D	>38 µm _(c) E	>70 µm _(c) F
000	195	76	14	3	1	0
00	390	152	27	5	1	0
0	780	304	54	10	2	0
1	1 560	609	109	20	4	1
2	3 120	1 217	217	39	7	1
3	6 250	2 432	432	76	13	2
4	12 500	4 864	864	152	26	4
5	25 000	9 731	1 731	306	53	8
6	50 000	19 462	3 462	612	106	16
7	100 000	38 924	6 924	1 224	212	32
8	200 000	77 849	13 849	2 449	424	64
9	400 000	155 698	27 698	4 898	848	128
10	800 000	311 396	55 396	9 796	1 696	256
11	1 600 000	622 792	110 792	19 592	3 392	512
12	3 200 000	1 245 584	221 584	39 184	6 784	1 024

> 4 µm _(c) = 45 000 particles
> 6 µm _(c) = 15 000 particles
> 14 µm _(c) = 1 500 particles
> 21 µm _(c) = 250 particles
> 38 µm _(c) = 15 particles
> 70 µm _(c) = 3 particle
Class from 2F to 4E

- CLASSES OF CONTAMINATION ACCORDING TO NAS 1638 (January 1964)

The NAS system was originally developed in 1964 to define contamination classes for the contamination contained within aircraft components.

The application of this standard was extended to industrial hydraulic systems simply because nothing else existed at the time.

The coding system defines the maximum numbers permitted of 100ml volume at various size intervals (differential counts) rather than using cumulative counts as in ISO 4406:1999. Although there is no guidance given in the standard on how to quote the levels, most industrial users quote a single code which is the highest recorded in all sizes and this convention is used on MP Filtri APC's.

The contamination classes are defined by a number (from 00 to 12) which indicates the maximum number of particles per 100 ml, counted on a differential basis, in a given size bracket.

Size Range Classes (in microns)

Maximum Contamination Limits per 100 ml					
Class	5÷15	15÷25	25÷50	50÷100	>100
00	125	22	4	1	0
0	250	44	8	2	0
1	500	89	16	3	1
2	1 000	178	32	6	1
3	2 000	356	63	11	2
4	4 000	712	126	22	4
5	8 000	1 425	253	45	8
6	16 000	2 850	506	90	16
7	32 000	5 700	1 012	180	32
8	64 000	11 400	2 025	360	64
9	128 000	22 800	4 050	720	128
10	256 000	45 600	8 100	1 440	256
11	512 000	91 200	16 200	2 880	512
12	1 024 000	182 400	32 400	5 760	1 024

5÷15 µm _(c) = 42 000 particles
15÷25 µm _(c) = 2 200 particles
25÷50 µm _(c) = 150 particles
50÷100 µm _(c) = 18 particles
> 100 µm _(c) = 3 particles
Class NAS 8

- CUMULATIVE DISTRIBUTION OF THE PARTICLES SIZE - ISO 4407

The level of contamination is defined by counting the number of particles collected by a laboratory membrane per unit of fluid volume. The measurement is done by a microscope.

The membrane must be cleaned, dried and desiccated, with fluid and conditions defined by the Standard. The fluid volume is filtered through the membrane, using a suitable suction system.

The level of contamination is identified by dividing the membrane into a predefined number of areas and by counting the contaminant particles using a suitable laboratory microscope.

MICROSCOPE CONTROL AND MEASUREMENT



COMPARISON PHOTOGRAPHS

1 graduation = 10µm



ISO 4406:1999	Class 16/14/11	Class 22/20/17
SAE AS4059E Table 1	Class 5	Class 11
NAS 1638	Class 5	Class 11
SAE AS4059E Table 2	Class 6A/5B/5C	Class 12A/11B/11C

CONTAMINATION MANAGEMENT

- CLEANLINESS CODE COMPARISON

Although ISO 4406:2017 standard is being used extensively within the hydraulics industry other standards are occasionally required and a comparison may be requested. The table below gives a very general comparison but often no direct comparison is possible due to the different classes and sizes involved.

ISO 4406:2017	SAE AS4059 Table 2	SAE AS4059 Table 1	NAS 1638
> 4 $\mu\text{m}_{(c)}$ 6 $\mu\text{m}_{(c)}$ 14 $\mu\text{m}_{(c)}$	> 4 $\mu\text{m}_{(c)}$ 6 $\mu\text{m}_{(c)}$ 14 $\mu\text{m}_{(c)}$	4-6 6-14 14-21 21-38 38-70 >70	5-15 15-25 25-50 50-100 >100
23 / 21 / 18	13A / 12B / 12C	12	12
22 / 20 / 17	12A / 11B / 11C	11	11
21 / 19 / 16	11A / 10B / 10C	10	10
20 / 18 / 15	10A / 9B / 9B	9	9
19 / 17 / 14	9A / 8B / 8C	8	8
18 / 16 / 13	8A / 7B / 7C	7	7
17 / 15 / 12	7A / 6B / 6C	6	6
16 / 14 / 11	6A / 5B / 5C	5	5
15 / 13 / 10	5A / 4B / 4C	4	4
14 / 12 / 09	4A / 3B / 3C	3	3

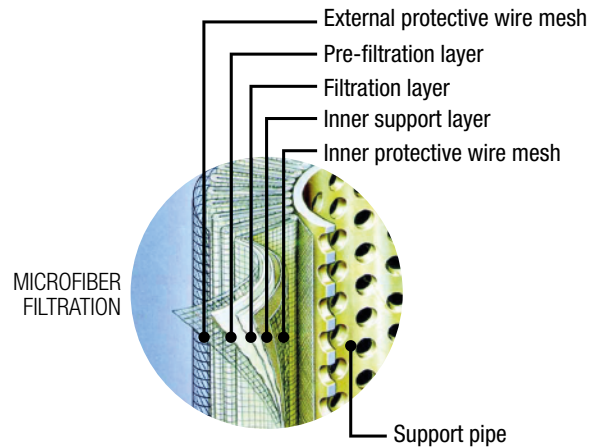

The filtration efficiency of metallic mesh filtrations is defined as the maximum particle size that can pass through the meshes of the filtering grid. The efficiency of microfibre and paper filtration ($\beta_{x(c)}$) is defined through a lab test called Multipass Test. The efficiency value ($\beta_{x(c)}$) is defined as the ratio between the number of particles of certain dimensions detected upstream and downstream of the filter.

$$\frac{\text{Upstream particles number} > X \mu\text{m}_{(c)}}{\text{Downstream particles number} > X \mu\text{m}_{(c)}} = \beta_{x(c)}$$

5 FILTRATION TECHNOLOGIES

Various mechanisms such as mechanical stoppage, magnetism, gravimetric deposit, or centrifugal separation can be used to reduce the level of contamination.

The mechanical stoppage method is most effective and can take place in two ways:

- SURFACE FILTRATION

It is by direct interception. The filter prevents particles larger than the pores from continuing in the plant / system. Surface filters are generally manufactured with metal canvases or meshes.

- DEPTH FILTERING

Filters are constructed by fiber interlacing. Such wraps form pathways of different shapes and sizes in which the particles remain trapped when they find smaller apertures than their diameter.

Depth filters are generally produced with papers impregnated with phenolic resins, metal fibers or inorganic fibers.

In inorganic fiber filtration, commonly called microfibre, the filtering layers are often overlapped in order to increase the ability to retain the contaminant.



Value ($\beta_{x(c)}$)	2	10	75	100	200	1000
Efficiency	50%	90%	98.7%	99%	99.5%	99.9%

Test conditions, such as type of fluid to be used (MIL-H-5606), type of contaminant to be used (ISO MTD), fluid viscosity, test temperature, are determined by ISO 16889.

In addition to the filtration efficiency value during the Multipass test, other important features, such as filtration stability (β stability) and dirt holding capacity (DHC), are also tested.

Poor filtration stability is the cause of the filtering quality worsening as the filter life rises. Low dirt holding capacity causes a reduction in the life of the filter.



Filtration ISO Standard Comparison		
$\beta_{x(c)} > 1000$ ISO 16889	$\beta_x > 200$ ISO 4572	MP Filtri Filter media code
5 $\mu\text{m}_{(c)}$	3 μm	A03
7 $\mu\text{m}_{(c)}$	6 μm	A06
10 $\mu\text{m}_{(c)}$	10 μm	A10
16 $\mu\text{m}_{(c)}$	18 μm	A16
21 $\mu\text{m}_{(c)}$	25 μm	A25

6 RECOMMENDED CONTAMINATION CLASSES

Any are the nature and the properties of fluids, they are inevitably subject to contamination. The level of contamination can be managed by using special components called filters.

Hydraulic components builders, knowing the problem of contamination, recommend the filtration level appropriate to the use of their products.

Example of recommended contamination levels for pressures below 140 bar.

Piston pumps with fixed flow rate	•					
Piston pumps with variable flow rate			•			
Vane pumps with fixed flow rate		•				
Vane pumps with variable flow			•			
Engines	•					
Hydraulic cylinders	•					
Actuators					•	
Test benches						•
Check valve	•					
Directional valves	•					
Flow regulating valves	•					
Proportional valves				•		
Servo-valves					•	
Flat bearings			•			
Ball bearings				•		
ISO 4406 CODE	20/18/15	19/17/14	18/16/13	17/15/12	16/14/11	15/13/10
Recommended filtration $\beta_{x(c)} \geq 1.000$	$\beta_{20(c)} > 1000$	$\beta_{15(c)} > 1000$	$\beta_{10(c)} > 1000$	$\beta_{7(c)} > 1000$	$\beta_{7(c)} > 1000$	$\beta_{5(c)} > 1000$

The common classification of filters is determined by their position in the plant.

7 TYPES OF FILTERS

Suction filters

They are positioned before the pump and are responsible for protecting the pump from dirty contaminants. It also provides additional flow guidance to the pump suction line.

Being subject to negligible working pressures are manufactured with simple and lightweight construction.

They are mainly produced with gross grade surface filtrations, mainly 60 ÷ 125 μm .

They can be equipped with a magnetic column for retaining ferrous particles.

They are generally placed under the fluid head to take advantage of the piezometric thrust of the fluid and reduce the risk of cavitation.

There are two types of suction filters:

- IMMERSION FILTERS

Simple filter element screwed on the suction pipe

- FILTERS WITH CONTAINER

Container filters that are more bulky, but provide easier maintenance of the tank

Delivery (or Pressure) filters

They are positioned between the pump and most sensitive regulating and controlling components, such as servo valves or proportional valves, and are designed to ensure the class of contamination required by the components used in the circuit.

Being subjected to high working pressures are manufactured with more robust and articulated construction. In particular situations of corrosive environments or aggressive fluids can be made of stainless steel.

They are mainly produced with filtering depths of 3 ÷ 25 μm .

They can be manufactured with in-line connections, with plate or flange connections or directly integrated into the circuit control blocks / manifolds.

They can also be manufactured in duplex configuration to allow the contaminated section to be maintained even when the plant / system is in operation without interruption of the working cycle.

Return filters

They are positioned on the return line to the tank and perform the task of filtering the fluid from particles entering the system from the outside or generated by the wear of the components.

They are generally fixed to the reservoir (for this reason also called top tank mounted), positioned semi-immersed or completely immersed.

The positioning of the return filters must guarantee in all operating conditions that the fluid drainage takes place in immersed condition; this is to avoid creating foams in the tank that can cause malfunctions or cavitation in the pumps.

For the sizing of the return filters, account must be taken of the presence of accumulators or cylinders that can make the return flow considerably greater than the pump suction flow rate.

Being subject to contained working pressures are manufactured with simple and lightweight construction.

Normally it is possible to extract the filter element without disconnecting the filter from the rest of the system.

Combined filters

They are designed to be applied to systems with two or more circuits. They are commonly used in hydrostatic transmission machines where they have a dual filtration function of the return line and suction line of the hydrostatic transmission pump.

The filter is equipped with a valve that keeps the 0.5 bar pressure inside the filter. A portion of the fluid that returns to the tank is filtered by the return filter element, generally produced with absolute filtration, and returns to the transmission booster pump.

Only excess fluid returns to the tank through the valve.

The internal pressure of the filter and the absolute filtration help to avoid the cavitation phenomenon inside the pump.

Off-line filters

They are generally used in very large systems / plants, placed in a closed circuit independent from the main circuit. They remain in operation regardless of the operation of the main circuit and are crossed by a constant flow rate.

They can also be manufactured in duplex configuration to allow the contaminated section to be maintained even when the unit is in operation without interruption of the work cycle.

Venting filters

During the operation of the plants, the fluid level present in the reservoir changes continuously.

The result of this continuous fluctuation is an exchange of air with the outside environment.

The venting filter function, positioned on the tank, is to filter the air that enters the tank to compensate for fluid level variations.

8 FILTER SIZING PARAMETERS

The choice of the filter system for an hydraulic system is influenced by several factors.

It is necessary to consider the characteristics of the various components present in the plant and their sensitivity to contamination.

It is also necessary to consider all the tasks that the filter will have to do within the plant:

- FLUID PROTECTION FROM CONTAMINATION
- PROTECTION OF OLEODYNAMIC COMPONENTS SENSITIVE TO CONTAMINATION
- PROTECTION OF OLEODYNAMIC PLANTS FROM ENVIRONMENTAL WASTE
- PROTECTION OF OLEODYNAMIC PLANTS FROM CONTAMINATION CAUSED BY COMPONENTS' FAILURES

The advantages of proper positioning and sizing of the filters are

- MORE RELIABILITY OF THE SYSTEM
- LONGER LIFE OF THE FLUID COMPONENTS
- REDUCTION OF STOP TIME
- REDUCTION OF FAILURE CASUALTIES

Each hydraulic filter is described by general features that identify the possibility of use in different applications.

- **MAXIMUM WORKING PRESSURE (P_{max})**

The maximum working pressure of the filter must be greater than or equal to the pressure of the circuit section in which it will be installed.

- **PRESSURE DROP (ΔP)**

The pressure drop depends on a number of factors, such as the working circuit temperature, the fluid viscosity, the filter element cleaning condition.

- **WORKING TEMPERATURE (T)**

The working temperature deeply affect the choice of materials. Excessively high or low temperatures may adversely affect the strength of the materials or the characteristics of the seals.

- **FILTRATION EFFICIENCY (%) / FILTRATION RATIO ($\beta_{x(c)}$)**

Filtration efficiency is the most important parameter to consider when selecting a filter.

When choosing the filtration performances, the needs of the most sensitive components in the system must be considered.

- **FLUID TYPE**

The type of fluid influences the choice of filters in terms of compatibility and viscosity. It is always mandatory to check the filterability.

- **PLACEMENT IN THE PLANT**

The position of the filter in the system conditions the efficiency of all filter performances.

9 APPLICABLE STANDARDS FOR FILTER DEVELOPMENT

In order to obtain unique criteria for development and verification of the filters performance, specific regulations for the filters and filter elements testing have been issued by ISO. These norms describe the target, the methodology, the conditions and the presentation methods for the test results.

ISO 2941

Hydraulic fluid power -- Filter elements -- Verification of collapse/burst pressure rating

This Standard describes the method for testing the collapse / burst resistance of the filter elements.

The test is performed by crossing the contaminated fluid filter element at a predefined flow rate. The progressive clogging of the filter element, determined by contamination, causes an increase in differential pressure.

ISO 2942

Hydraulic fluid power -- Filter elements -- Verification of fabrication integrity and determination of the first bubble point

This Standard describes the method to verify the integrity of the assembled filter elements.

It can be used to verify the quality of the production process or the quality of the materials by verifying the pressure value of the first bubble point.

ISO 2943

Hydraulic fluid power -- Filter elements -- Verification of material compatibility with fluids

This Standard describes the method to verify the compatibility of materials with certain hydraulic fluids.

The test is carried out by keeping the element (the material sample) immersed in the fluid under high or low temperature conditions for a given period of time and verifying the retention of the characteristics.

ISO 3723

Hydraulic fluid power -- Filter elements -- Method for end load test

This Standard describes the method for verifying the axial load resistance of the filter elements.

After performing the procedure described in ISO 2943, the designed axial load is applied to the filter element. To verify the test results, then the test described in ISO 2941 is performed.

ISO 3968

Hydraulic fluid power -- Filters -- Evaluation of differential pressure versus flow characteristics

This Standard describes the method for checking the pressure drop across the filter.

The test is carried out by crossing the filter from a given fluid and by detecting upstream and downstream pressures.

Some of the parameters defined by the Standard are the fluid, the test temperature, the size of the tubes, the position of the pressure detection points.

ISO 16889

Hydraulic fluid power -- Filters -- Multi-pass method for evaluating filtration performance of a filter element

This Standard describes the method to check the filtration characteristics of the filter elements.

The test is performed by constant introduction of contaminant (ISO MTD). The characteristics observed during the test are the filtration efficiency and the dirty holding capacity related to the differential pressure.

ISO 23181

Hydraulic fluid power -- Filter elements -- Determination of resistance to flow fatigue using high viscosity fluid

This Standard describes the method for testing the fatigue resistance of the filter elements.

The test is carried out by subjecting the filter to continuous flow variations, thus differential pressure, using a high viscosity fluid.

ISO 11170

Hydraulic fluid power -- Sequence of tests for verifying performance characteristics of filter elements

The Standard describes the method for testing the performance of filter elements. The protocol described by the regulations provides the sequence of all the tests described above in order to verify all the working characteristics (mechanical, hydraulic and filtration).

ISO 10771-1

Hydraulic fluid power -- Fatigue pressure testing of metal pressure-containing envelopes -- Test method

This Standard describes the method to check the resistance of the hydraulic components with pulsing pressure.

It can be applied to all metal components (excluding tubes) subject to cyclic pressure used in the hydraulic field.

10 WATER IN HYDRAULIC AND LUBRICATING FLUIDS

Water Content

In mineral oils and non aqueous resistant fluids water is undesirable. Mineral oil usually has a water content of 50-300 ppm (@40°C) which it can support without adverse consequences.

Once the water content exceeds about 300ppm the oil starts to appear hazy. Above this level there is a danger of free water accumulating in the system in areas of low flow. This can lead to corrosion and accelerated wear.

Similarly, fire resistant fluids have a natural water which may be different to mineral oil.

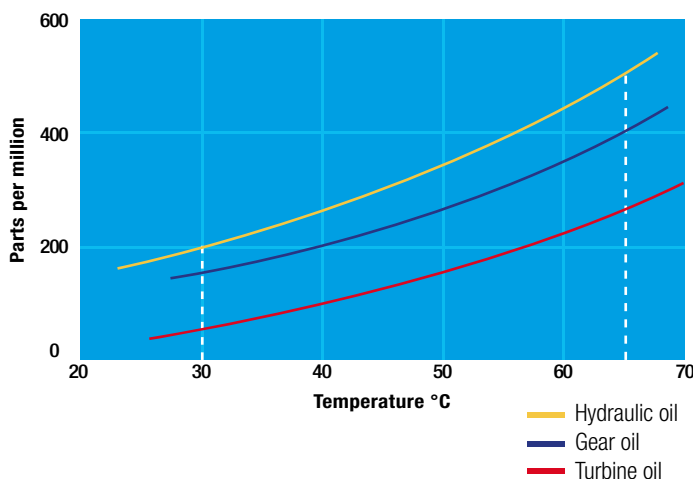

Saturation Levels

Since the effects of free (also emulsified) water is more harmful than those of dissolved water, water levels should remain well below the saturation point.

However, even water in solution can cause damage and therefore every reasonable effort should be made to keep saturation levels as low as possible. There is no such thing as too little water. As a guideline, we recommend maintaining saturation levels below 50% in all equipment.

TYPICAL WATER SATURATION LEVEL FOR NEW OILS

Examples:

Hydraulic oil @ 30°C = 200ppm = 100% saturation

Hydraulic oil @ 65°C = 500ppm = 100% saturation

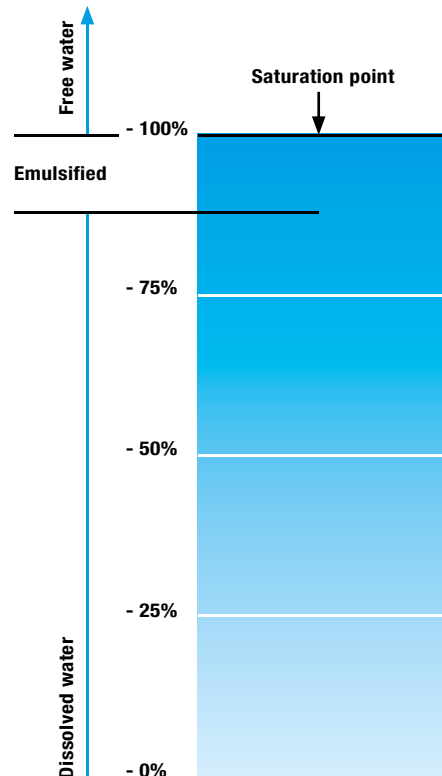

CONTAMINATION MANAGEMENT

Water absorber

Water is present everywhere, during storage, handling and servicing.

MP Filtri filter elements feature an absorbent media which protects hydraulic systems from both particulate and water contamination.

MP Filtri's filter element technology is available with inorganic microfiber media with a filtration rating 25 μm (therefore identified with media designation WA025, providing absolute filtration of solid particles to $\beta_{x(c)} = 1000$).

Absorbent media is made by water absorbent fibres which increase in size during the absorption process.

Free water is thus bonded to the filter media and completely removed from the system (it cannot even be squeezed out).

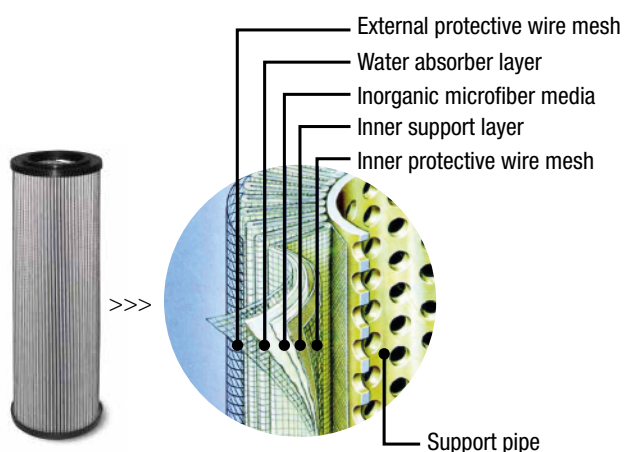
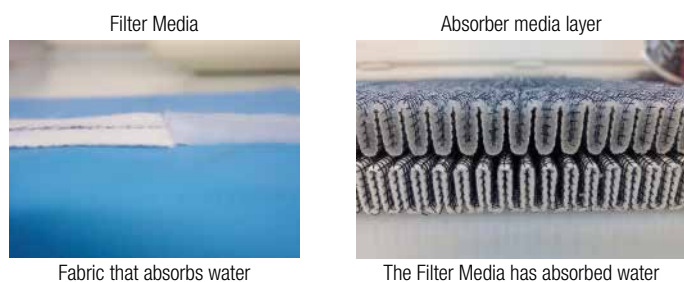

By removing water from your fluid power system, you can prevent such key problems as:

- corrosion (metal etching)
- loss of lubricant power
- accelerated abrasive wear in hydraulic components
- valve-locking
- bearing fatigue
- viscosity variance (reduction in lubricating properties)
- additive precipitation and oil oxidation
- increase in acidity level
- increased electrical conductivity (loss of dielectric strength)
- slow/weak response of control systems

Product availability:

LOW & MEDIUM PRESSURE FILTERS - LMP Series

LMP 210	LMP 900
LMP 211	LMP 901
LMP 400	LMP 902
LMP 401	LMP 903
LMP 430	LMP 950
LMP 431	LMP 951

FILTER SIZING

INDEX

	Page
CALCULATION	23
CORRECTIVE FACTOR	24

THE CORRECT FILTER SIZING HAVE TO BE BASED ON THE TOTAL PRESSURE DROP DEPENDING BY THE APPLICATION.

FOR EXAMPLE, THE MAXIMUM TOTAL PRESSURE DROP ALLOWED BY A NEW AND CLEAN RETURN FILTER HAVE TO BE IN THE RANGE 0.4 ÷ 0.6 bar.

The pressure drop calculation is performed by adding together the value of the housing with the value of the filter element. The pressure drop Δpc of the housing is proportional to the fluid density (kg/dm³); all the graphs in the catalogue are referred to mineral oil with density of 0.86 kg/dm³.

The filter element pressure drop Δpe is proportional to its viscosity (mm²/s), the corrective factor Y have to be used in case of an oil viscosity different than 30 mm²/s (cSt).

Sizing data for single filter element, head at top

Δpc = Filter housing pressure drop [bar]

Δpe = Filter element pressure drop [bar]

Y = Corrective factor Y (see correspondent table), depending on the filter type, on the filter element size, on the filter element length and on the filter media

Q = flow rate (l/min)

V1 reference oil viscosity = 30 mm²/s (cSt)

V2 = operating oil viscosity in mm²/s (cSt)

Filter element pressure drop calculation with an oil viscosity different than 30 mm²/s (cSt)

$\Delta pe = Y : 1000 \times Q \times (V2:V1)$

$\Delta p \text{ Tot.} = \Delta pc + \Delta pe$

Verification formula

$\Delta p \text{ Tot.} \leq \Delta p \text{ max allowed}$

Maximum total pressure drop (Δp max) allowed by a new and clean filter

Application	Range (bar)
Suction filters	0.08 ÷ 0.10
Return filters	0.4 ÷ 0.6
	0.4 ÷ 0.6 return lines
	0.3 ÷ 0.5 lubrication lines
Low & Medium Pressure filters	0.3 ÷ 0.4 off-line in power systems
	0.1 ÷ 0.3 off-line in test benches
	0.4 ÷ 0.6 over-boost
High Pressure filters	0.8 ÷ 1.5
Stainless Steel filters	0.8 ÷ 1.5

Generic filter calculation example

Application data:

Tank top return filter

Pressure Pmax = 10 bar

Flow rate Q = 120 l/min

Viscosity V2 = 46 mm²/s (cSt)

Oil density = 0.86 kg/dm³

Required filtration efficiency = 25 μm with absolute filtration

With bypass valve and G 1 1/4" inlet connection

Calculation:

Δpc = 0.03 bar (see graphic below)

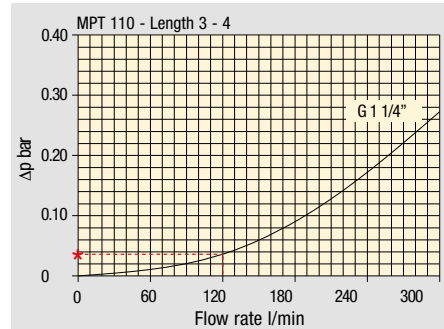

Filter housings Δp pressure drop. The curves are plotted using mineral oil with density of 0.86 kg/dm³ in compliance with ISO 3968. Δp varies proportionally with density.

$\Delta pe = (2.00 : 1000) \times 120 \times (46 : 30) = 0.37 \text{ bar}$

Filter element	Absolute filtration H Series					Nominal filtration N Series		
	A03	A06	A10	A16	A25	P10	P25	M25 M60 M90
Type								
Return filters								
MF 020	74.00	50.08	20.00	16.00	9.00	6.43	5.51	4.40
	2	29.20	24.12	8.00	7.22	5.00	3.33	2.85
	3	22.00	19.00	6.56	5.33	4.33	1.68	1.44
MF 030	74.00	50.08	20.00	16.00	9.00	6.43	5.51	3.40
MFX 030	1	28.20	24.40	8.67	8.17	6.88	4.62	3.96
	2	17.33	12.50	6.86	5.70	4.00	3.05	2.47
	3	10.25	9.00	3.65	3.33	2.50	1.63	1.32
	4	6.10	5.40	2.30	2.20	2.00	1.19	0.96
MF 100								
MFX 100								

$\Delta p \text{ Tot.} = 0.03 + 0.37 = 0.4 \text{ bar}$

The selection is correct because the total pressure drop value is inside the admissible range for top tank return filters.

In case the allowed max total pressure drop is not verified, it is necessary to repeat the calculation changing the filter length/size.

FILTER SIZING Corrective factor

Corrective factor Y to be used for the filter element pressure drop calculation. The values depend to the filter size and length and to the filter media.
Reference oil viscosity 30 mm²/s

Return filters

Filter element	Absolute filtration H Series					Nominal filtration N Series			
	Type	A03	A06	A10	A16	A25	P10	P25	M25 M60 M90
MF 020	1	74.00	50.08	20.00	16.00	9.00	6.43	5.51	4.40
	2	29.20	24.12	8.00	7.22	5.00	3.33	2.85	2.00
	3	22.00	19.00	6.56	5.33	4.33	1.68	1.44	1.30
MF 030 MFX 030	1	74.00	50.08	20.00	16.00	9.00	6.43	5.51	3.40
MF 100 MFX 100	1	28.20	24.40	8.67	8.17	6.88	4.62	3.96	1.25
	2	17.33	12.50	6.86	5.70	4.00	3.05	2.47	1.10
	3	10.25	9.00	3.65	3.33	2.50	1.63	1.32	0.96
	4	6.10	5.40	2.30	2.20	2.00	1.19	0.96	0.82
MF 180 MFX 180	1	3.67	3.05	1.64	1.56	1.24	1.18	1.06	0.26
	2	1.69	1.37	0.68	0.54	0.51	0.43	0.39	0.12
MF 190 MFX 190	2	1.69	1.37	0.60	0.49	0.44	0.35	0.31	0.11
MF 400 MFX 400	1	3.20	2.75	1.39	1.33	1.06	0.96	0.87	0.22
	2	2.00	1.87	0.88	0.85	0.55	0.49	0.45	0.13
	3	1.90	1.60	0.63	0.51	0.49	0.39	0.35	0.11
MF 750 MFX 750	1	1.08	0.84	0.49	0.36	0.26	0.21	0.19	0.06
MLX 250	2	3.00	3.04	1.46	1.25	1.17	-	-	M25 0.20
MLX 660	2	1.29	1.26	0.52	0.44	0.38	-	-	M25 0.10
CU 025		78.00	48.00	28.00	24.00	9.33	9.33	8.51	1.25
CU 040		25.88	20.88	10.44	10.00	3.78	3.78	3.30	1.25
CU 100		15.20	14.53	5.14	4.95	2.00	2.00	0.17	1.10
CU 250		3.25	2.55	1.55	1.35	0.71	0.71	0.59	0.25
CU 630		1.96	1.68	0.85	0.72	0.42	0.42	0.36	0.09
CU 850		1.06	0.84	0.42	0.33	0.17	0.17	0.13	0.04
MR 100	1	19.00	17.00	6.90	6.30	4.60	2.94	2.52	1.60
	2	11.70	10.80	4.40	4.30	3.00	2.94	2.52	1.37
	3	7.80	6.87	3.70	3.10	2.70	2.14	1.84	1.34
	4	5.50	4.97	2.60	2.40	2.18	1.72	1.47	1.34
	5	4.20	3.84	2.36	2.15	1.90	1.60	1.37	1.34
MR 250	1	5.35	4.85	2.32	1.92	1.50	1.38	1.20	0.15
	2	4.00	3.28	1.44	1.10	1.07	0.96	0.83	0.13
	3	2.60	2.20	1.08	1.00	0.86	0.77	0.64	0.12
	4	1.84	1.56	0.68	0.56	0.44	0.37	0.23	0.11
MR 630	1	3.10	2.48	1.32	1.14	0.92	0.83	0.73	0.09
	2	2.06	1.92	0.82	0.76	0.38	0.33	0.27	0.08
	3	1.48	1.30	0.60	0.56	0.26	0.22	0.17	0.08
	4	1.30	1.20	0.48	0.40	0.25	0.21	0.16	0.08
	5	0.74	0.65	0.30	0.28	0.13	0.10	0.08	0.04
MR 850	1	0.60	0.43	0.34	0.25	0.13	0.12	0.09	0.03
	2	0.37	0.26	0.23	0.21	0.11	0.08	0.07	0.03
	3	0.27	0.18	0.17	0.17	0.05	0.04	0.04	0.02
	4	0.23	0.16	0.13	0.12	0.04	0.03	0.03	0.02

Return / Suction filters

Filter element	Absolute filtration			
	Type	A10	A16	A25
RSX 116	1	5.12	4.33	3.85
	2	2.22	1.87	1.22
RSX 165	1	2.06	1.75	1.46
	2	1.24	1.05	0.96
	3	0.94	0.86	0.61

Filter element	Absolute filtration N Series								
	Type	A03	A06	A10	A16	A25	P10	P25	M25 M60 M90
CU 110	1	16.25	15.16	8.75	8.14	5.87	2.86	2.65	0.14
	2	12.62	10.44	6.11	6.02	4.16	1.60	1.49	0.12
	3	8.57	7.95	5.07	4.07	2.40	1.24	1.15	0.11
	4	5.76	4.05	2.80	2.36	1.14	0.91	0.85	0.05

Low & Medium pressure filters

Filter element	Absolute filtration N-W Series					Nominal filtration N Series			
	Type	A03	A06	A10	A16	A25	P10	P25	M25
CU 110	1	16.25	15.16	8.75	8.14	5.87	2.86	2.65	0.14
	2	12.62	10.44	6.11	6.02	4.15	1.60	1.49	0.12
	3	8.57	7.95	5.07	4.07	2.40	1.24	1.15	0.11
	4	5.76	4.05	2.80	2.36	1.14	0.91	0.85	0.05
CU 210	1	5.30	4.80	2.00	1.66	1.32	0.56	0.43	0.12
	2	3.44	2.95	1.24	1.09	0.70	0.42	0.35	0.09
	3	2.40	1.70	0.94	0.84	0.54	0.33	0.23	0.05
DN	016	7.95	7.20	3.00	2.49	1.98	0.84	0.65	0.18
	025	5.00	4.53	1.89	1.57	1.25	0.53	0.41	0.11
	040	3.13	2.66	1.12	0.98	0.63	0.38	0.32	0.08
CU 400	2	3.13	2.55	1.46	1.22	0.78	0.75	0.64	0.19
	3	2.15	1.70	0.94	0.78	0.50	0.40	0.34	0.10
	4	1.60	1.28	0.71	0.61	0.40	0.34	0.27	0.08
	5	1.00	0.83	0.47	0.34	0.20	0.24	0.19	0.06
	6	0.82	0.58	0.30	0.27	0.17	0.22	0.18	0.05
	CU 900	1	0.86	0.63	0.32	0.30	0.21	-	-
CU 950	2	1.03	0.80	0.59	0.40	0.26	-	-	0.05
	3	0.44	0.40	0.27	0.18	0.15	-	-	0.02
MR 630	7	0.88	0.78	0.36	0.34	0.16	0.12	0.96	0.47

Corrective factor Y to be used for the filter element pressure drop calculation. The values depend to the filter size and length and to the filter media.
Reference oil viscosity 30 mm²/s

High pressure filters

Filter element	Absolute filtration N - R Series					Nominal filtration N Series	
	Type	A03	A06	A10	A16	A25	M25
HP 011	1	332.71	250.07	184.32	152.36	128.36	-
	2	220.28	165.56	74.08	59.13	37.05	-
	3	123.24	92.68	41.48	33.08	20.72	-
	4	77.76	58.52	28.37	22.67	16.17	-
HP 039	2	70.66	53.20	25.77	20.57	14.67	4.90
	3	36.57	32.28	18.00	13.38	8.00	2.90
	4	26.57	23.27	12.46	8.80	5.58	2.20
HP 050	1	31.75	30.30	13.16	12.3	7.29	1.60
	2	24.25	21.26	11.70	9.09	4.90	1.40
	3	17.37	16.25	8.90	7.18	3.63	1.25
	4	12.12	10.75	6.10	5.75	3.08	1.07
	5	7.00	6.56	3.60	3.10	2.25	0.80
HP 065	1	58.50	43.46	23.16	19.66	10.71	1.28
	2	42.60	25.64	16.22	13.88	7.32	1.11
	3	20.50	15.88	8.18	6.81	3.91	0.58
HP 135	1	20.33	18.80	9.71	8.66	4.78	2.78
	2	11.14	10.16	6.60	6.38	2.22	1.11
	3	6.48	6.33	3.38	3.16	2.14	1.01
HP 150	1	17.53	15.91	7.48	6.96	5.94	1.07
	2	8.60	8.37	3.54	3.38	3.15	0.58
	3	6.53	5.90	2.93	2.79	2.12	0.49
HP 320	1	10.88	9.73	5.02	3.73	2.54	1.04
	2	4.40	3.83	1.75	1.48	0.88	0.71
	3	2.75	2.11	1.05	0.87	0.77	0.61
	4	2.12	1.77	0.98	0.78	0.55	0.47
HP 500	1	4.44	3.67	2.30	2.10	1.65	0.15
	2	3.37	2.77	1.78	1.68	1.24	0.10
	3	2.22	1.98	1.11	1.09	0.75	0.08
	4	1.81	1.33	0.93	0.86	0.68	0.05
	5	1.33	1.15	0.77	0.68	0.48	0.04

Filter element	Absolute filtration N Series					Nominal filtration N Series	
	Type	A03	A06	A10	A16	A25	M25
HF 320	1	3.65	2.95	2.80	1.80	0.90	0.38
	2	2.03	1.73	1.61	1.35	0.85	0.36
	3	1.84	1.42	1.32	1.22	0.80	0.35

Suction filters

Filter element	Nominal filtration N Series	
	P10	P25
SF 250	65	21

Stainless steel high pressure filters

Filter element	Absolute filtration N Series					
	Type	A03	A06	A10	A16	A25
HP 011	1	332.71	250.07	184.32	152.36	128.36
	2	220.28	165.56	74.08	59.13	37.05
	3	123.24	92.68	41.48	33.08	20.72
	4	77.76	58.52	28.37	22.67	16.17
HP 039	2	70.66	53.20	25.77	20.57	14.67
	3	36.57	32.28	18.00	13.38	8.00
	4	26.57	23.27	12.46	8.80	5.58
HP 050	1	31.75	30.30	13.16	12.3	7.29
	2	24.25	21.26	11.70	9.09	4.90
	3	17.37	16.25	8.90	7.18	3.63
	4	12.12	10.75	6.10	5.75	3.08
	5	7.00	6.56	3.60	3.10	2.25
HP 135	1	20.33	18.80	9.71	8.66	4.78
	2	11.14	10.16	6.60	6.38	2.22
	3	6.48	6.33	3.38	3.16	2.14

Filter element	Absolute filtration H - U Series					
	Type	A03	A06	A10	A16	A25
HP 011	1	424.58	319.74	235.17	194.44	163.78
	2	281.06	211.25	94.53	75.45	47.26
	3	130.14	97.50	43.63	34.82	21.81
	4	109.39	82.25	36.79	29.37	18.40
HP 039	2	70.66	53.20	25.77	20.57	14.67
	3	36.57	32.28	18.00	13.38	8.00
	4	26.57	23.27	12.46	8.80	5.58
HP 050	1	47.33	34.25	21.50	20.50	14.71
	2	29.10	25.95	14.04	10.90	5.88
	3	20.85	19.50	10.68	8.61	4.36
	4	14.55	12.90	7.32	6.90	3.69
	5	9.86	9.34	6.40	4.80	2.50
HP 135	1	29.16	25.33	13.00	12.47	5.92
	2	14.28	11.04	7.86	7.60	4.44
	3	8.96	7.46	4.89	4.16	3.07

FILTER SIZING Selection Software

Step 1 Select "FILTERS"

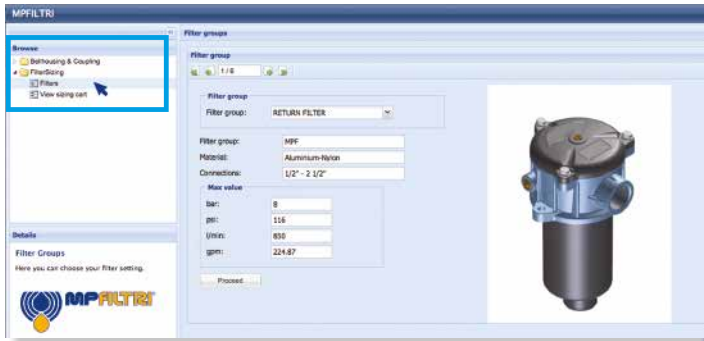

Step 2 Choose filter group (Return Filter, Pressure Filter, etc.)



Step 3 Choose filter type (MPF, MPT, etc.) in function of the max working pressure and the max flow rate

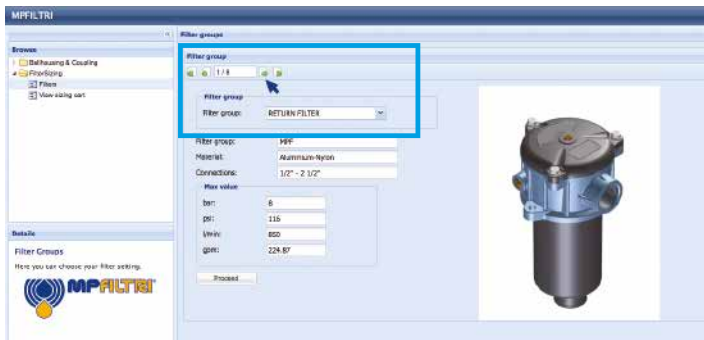

Step 4 Push "PROCEED"

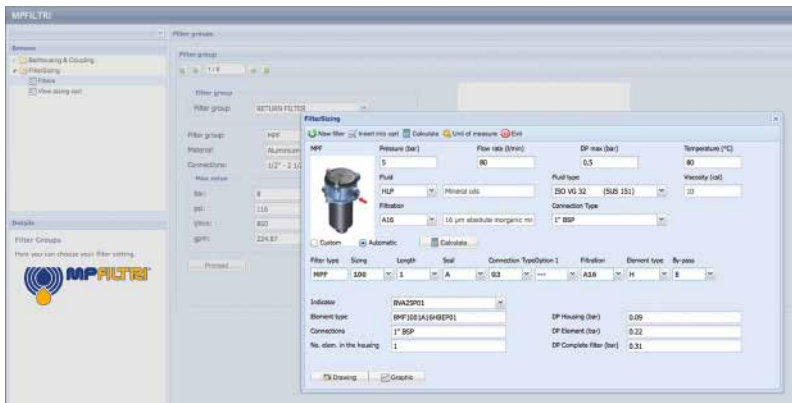
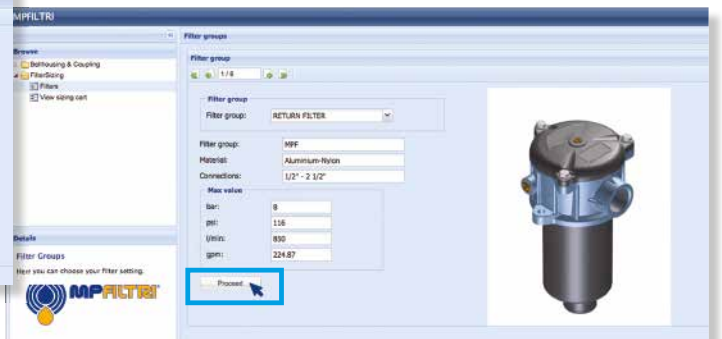

Step 5

Insert all application data to calculate the filter size following the sequence:

- working pressure
- working flow rate
- working pressure drop
- working temperature
- fluid material and fluid type
- filtration media
- connection type

Step 6

Push "CALCULATE" to have result; in case of any mistake, the system will advice which parameter is out of range to allow to modify/adjust the selection



Step 7

Download PDF Datasheet "Report.aspx" pushing the button "Drawing"

Spin-On filters are used as process and safety filters to protect individual pumps, valves or the entire hydraulic circuit from contamination as per ISO 4406.

In-line Spin-On filters can be used for the following purposes:

- **Suction filters**
- **On the return circuit, for mounting on the line or on the tank cover**
- **In-line for low and medium pressure applications**

Spin-On filters are available in 4 configurations:

- **Single cartridge in-line**
- **In-line with two parallel cartridges on the same axis**
- **In-line with two parallel cartridges mounted side by side**

All versions may be equipped with visual and/or electrical blockage indicators.

Spin-on filters



MPS	page 289
MSH	305
INDICATORS	311

MPS series

Maximum working pressure up to 1.2 MPa (12 bar) - Flow rate up to 365 l/min



Description

Technical data

Spin-on filters

Maximum working pressure up to 1.2 MPa (12 bar)

Flow rate up to 365 l/min

MPS is a range of spin-on filters suitable to be used in suction, return and low pressure lines.

They offer a good balance between performances, dimensions and prices. They are directly connected to the lines of the system through the hydraulic fittings.

Available features:

- Female threaded connections up to 1 1/2" and flanged connections up to 1 1/2", for a maximum flow rate of 365 l/min.
- Fine filtration rating, to get a good cleanliness level into the reservoir
- Water removal elements, to remove the free water from the hydraulic fluid
- Double connection for the cans, to fit both European and American standard elements
- Double cans fitting, to increase the life time of the filter
- Bypass valve, to relieve excessive pressure drop across the filter media
- Visual, electrical and electronic clogging indicators for suction and return applications
- Visual, electrical and electronic differential clogging indicators for low pressure applications

Common applications:

- Suction lines, Return lines, Delivery lines, in economic industrial equipment or mobile machines.
- Off-line filtration tank in economic industrial equipment or mobile machines

Filter housing materials

- Head: Aluminium
- Bypass valve: Nylon - Steel
- Element: Zinc-Plated Steel - Painted Steel

Bypass valve

- Return filter opening pressure: 175 kPa (1.75 bar) $\pm 10\%$
- Suction filter opening pressure: 30 kPa (0.3 bar) $\pm 10\%$

Δp element type

- Δp : 5 bar
- Fluid flow through the filter element from OUT to IN

Seals

Standard NBR - series A

Temperature

From -20 °C to +110 °C

Note

MPS filters are provided for vertical mounting



Weights [kg] and volumes [dm³]

Filter series	Weights [kg]	Volumes [dm ³]
MPS 050	1.00	0.70
MPS 051	1.05	0.70
MPS 070	1.20	0.95
MPS 071	1.25	0.95
MPS 100	2.10	1.65
MPS 101	2.20	1.65
MPS 150	2.40	2.00
MPS 151	2.50	2.00
MPS 200	3.90	3.00
MPS 250	4.60	3.70
MPS 300-301	5.30	3.40
MPS 350-351	6.00	4.10

Bypass valve
pressure drop

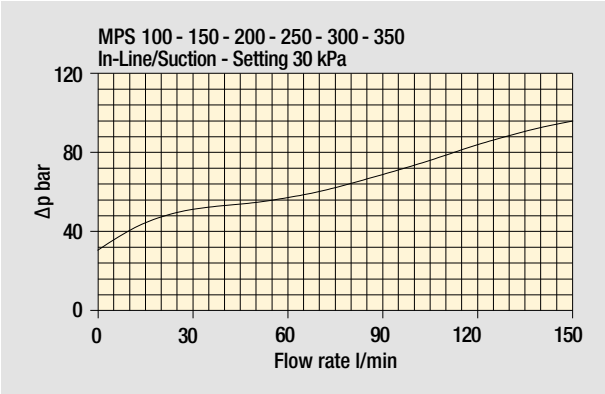
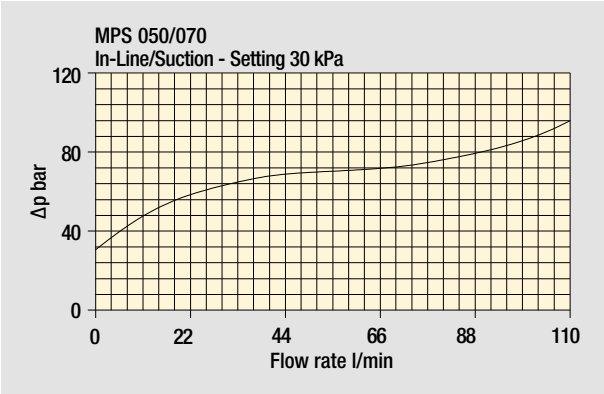
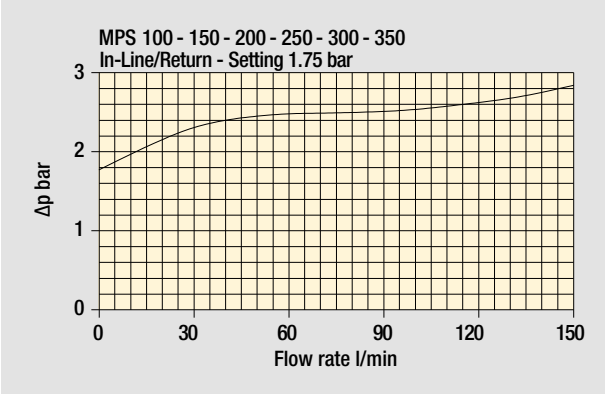
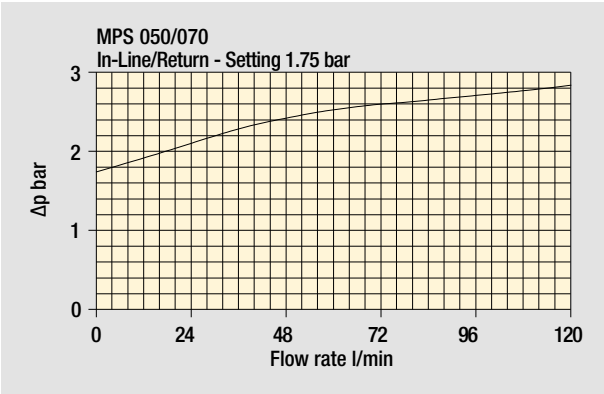

The curves are plotted using mineral oil with density of 0.86 kg/dm³ in compliance with ISO 3968.
 Δp varies proportionally with density.

MPS GENERAL INFORMATION

Hydraulic symbols

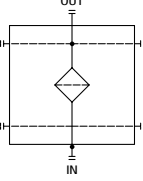
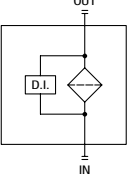
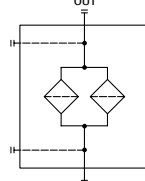
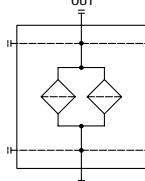
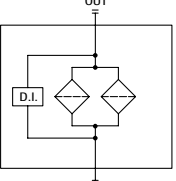
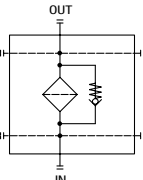
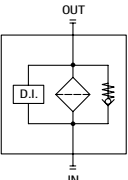
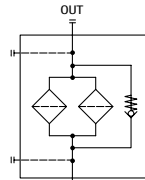
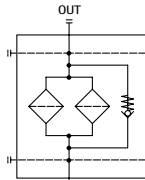
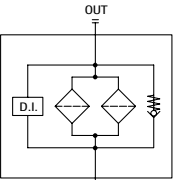
Filter series					
MPS 050	•				
MPS 051		•			
MPS 070	•				
MPS 071		•			
MPS 100	•				
MPS 101		•			
MPS 150	•				
MPS 151		•			
MPS 200			•		
MPS 250			•		
MPS 300				•	
MPS 301				•	•
MPS 350				•	
MPS 351					•
	Style U/P	Style U/P	Style U	Style U/P	Style U/P
					
	Style R/S	Style R/S	Style R/S	Style R/S	Style R/S
					

CS 050 - 070 - 100 - 150
CG - CW 050 - 070



CG - CW 100 - 150



CW
 This series of cartridge removes water from oil while filtering the oil at the same time. Water absorbent polymers up to 800 times their own weight provide this major feature.

Water holding capacities:
 CW 050= 240 ml
 Ordering code: **CW050P10AP01**

CW 150= 788 ml
 Ordering code: **CW150P10AP01**

Thread connections	
Element	Connection
CS 050 - 070	G 3/4"
CS 100 - 150	G 1 1/4"
CG / CW 050 - 070	1" - 12 UNF
CG / CW 100 - 150	1 1/2" - 16 UN

Water holding capacities CW		
	good	poor
Viscosity	30/46 mm ² /s (cSt)	> 46 mm ² /s (cSt)
H ₂ O p.p.m.	600/800 p.p.m.	> 800 p.p.m.
Flow rate	CW050 7/15 l/min CW150 20/40 l/min	CW050 > 20 l/min CW150 > 50 l/min
Temperature	40/60 °C	< 30 °C

Heads

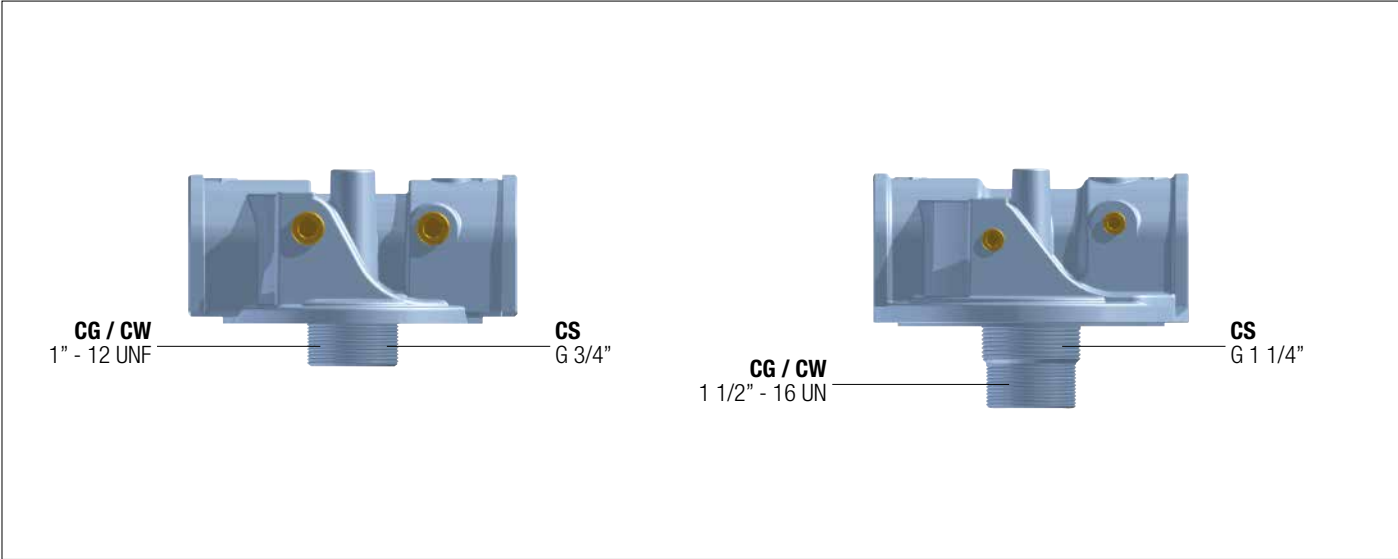

MPS MPS050 - MPS070 MPS051 - MPS071

Designation & Ordering code

COMPLETE FILTER

Series and size

MPS050 | **MPS070** With connections for clogging indicators

MPS051 | **MPS071** With connections for differential indicators

Configuration example: **MPS050** **R** **G1** **A10** **A** **P01**

Bypass valve

	MPS 050 - 070	MPS 051 - 071
R Return: 1.75 bar	•	•
S Suction: 30 kPa	•	
U Without bypass	•	
P Without bypass		•

Connections

G1 G 3/4"
G2 3/4" NPT
G3 SAE 12 - 1 1/16" - 12 UN
G4 SAE 8 - 3/4" - 16 UNF
G5 G 1"
G6 1" NPT

Filtration rating (filter media)

A03 Inorganic microfiber 3 µm	M25 Wire mesh 25 µm
A06 Inorganic microfiber 6 µm	M60 Wire mesh 60 µm
A10 Inorganic microfiber 10 µm	M90 Wire mesh 90 µm
A25 Inorganic microfiber 25 µm	P10 Resin impregnated paper 10 µm
	P25 Resin impregnated paper 25 µm

Seal

A NBR

Execution

P01 MP Filtri standard

CARTRIDGE

Cartridge series and size

CS050 | **CS070**

Configuration example: **CS050** **A10** **A** **P01**

Filtration rating (filter media)

A03 Inorganic microfiber 3 µm	M25 Wire mesh 25 µm
A06 Inorganic microfiber 6 µm	M60 Wire mesh 60 µm
A10 Inorganic microfiber 10 µm	M90 Wire mesh 90 µm
A25 Inorganic microfiber 25 µm	P10 Resin impregnated paper 10 µm
	P25 Resin impregnated paper 25 µm

Seals

A NBR

Execution

P01 MP Filtri standard

Pxx Customized

ACCESSORIES

Clogging indicators on RETURN line

	page
BVA Axial pressure gauge	315
BVR Radial pressure gauge	315
BVP Visual pressure indicator with automatic reset	316
BVQ Visual pressure indicator with manual reset	316

	page
BEA Electrical pressure indicator	314
BEM Electrical pressure indicator	314
BLA Electrical / visual pressure indicator	314-315

Clogging indicators on SUCTION line

	page
VVB Axial pressure gauge	313
VVS Radial pressure gauge	313

	page
VEB Electrical vacuum indicator	312
VLB Electrical/visual vacuum indicator	312

Differential indicators

	page
DEA Electrical differential indicator	317
DEM Electrical differential indicator	317-318
DLA Electrical / visual differential indicator	318-319
DLE Electrical / visual differential indicator	319

	page
DTA Electronic differential indicator	320
DVA Visual differential indicator	320
DVM Visual differential indicator	320

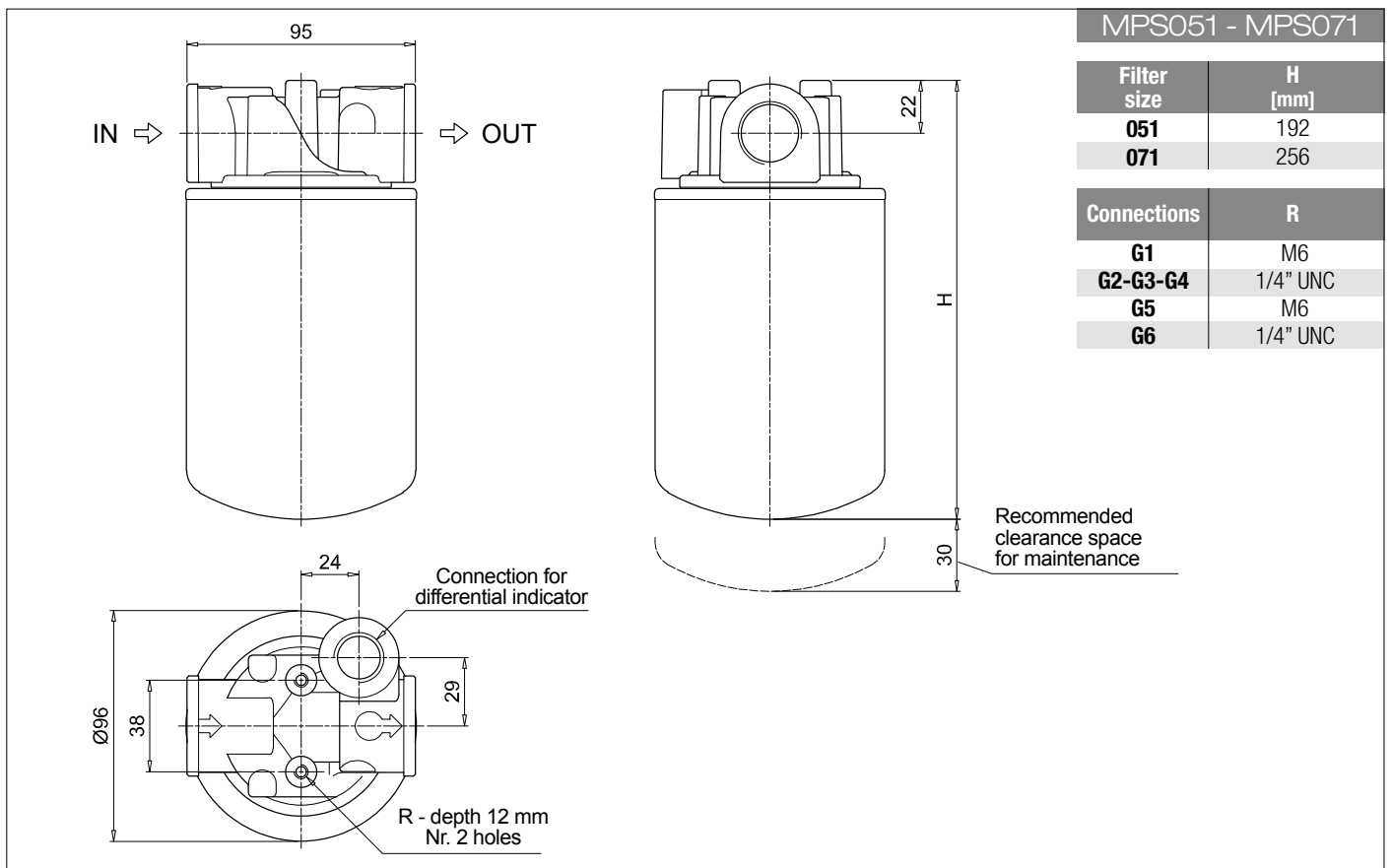
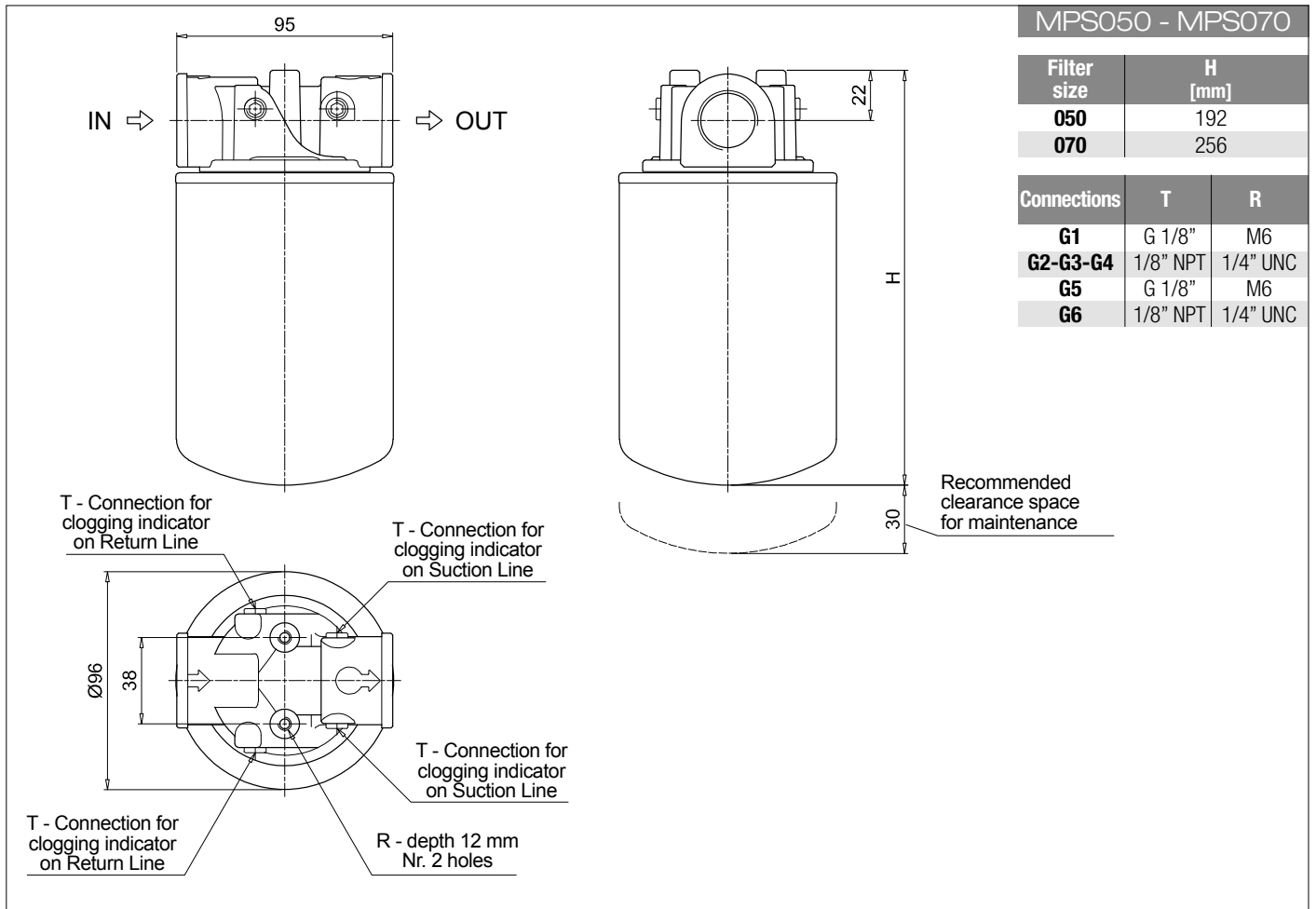

MPS MPS100 - MPS150 MPS101 - MPS151

Designation & Ordering code

COMPLETE FILTER

Series and size		Configuration example: MPS100 R G1 A10 A P01				
MPS100 MPS150	With connections for clogging indicators					
MPS101 MPS151	With connections for differential indicators					
Bypass valve		MPS 100 - 150	MPS 101 - 151			
R	Return: 1.75 bar	•	•			
S	Suction: 30 kPa	•				
U	Without bypass	•				
P	Without bypass		•			
Connections						
G1	G 1 1/4"					
G2	1 1/4" NPT					
G3	SAE 20 - 1 5/8" - 12 UN					
Filtration rating (filter media)						
A03	Inorganic microfiber 3 µm			M25	Wire mesh 25 µm	
A06	Inorganic microfiber 6 µm			M60	Wire mesh 60 µm	
A10	Inorganic microfiber 10 µm			M90	Wire mesh 90 µm	
A25	Inorganic microfiber 25 µm			P10	Resin impregnated paper 10 µm	
				P25	Resin impregnated paper 25 µm	
				Seal	A NBR	
				Execution	P01 MP Filtri standard	

CARTRIDGE

Cartridge series and size		Configuration example: CS100 A10 A P01			
CS100 CS150					
Filtration rating (filter media)					
A03	Inorganic microfiber 3 µm			M25	Wire mesh 25 µm
A06	Inorganic microfiber 6 µm			M60	Wire mesh 60 µm
A10	Inorganic microfiber 10 µm			M90	Wire mesh 90 µm
A25	Inorganic microfiber 25 µm			P10	Resin impregnated paper 10 µm
				P25	Resin impregnated paper 25 µm
				Seals	A NBR
				Execution	P01 MP Filtri standard Pxx Customized

ACCESSORIES

Clogging indicators on RETURN line		page	Clogging indicators on SUCTION line		page
BVA	Axial pressure gauge	315	BEA	Electrical pressure indicator	314
BVR	Radial pressure gauge	315	BEM	Electrical pressure indicator	314
BVP	Visual pressure indicator with automatic reset	316	BLA	Electrical / visual pressure indicator	314-315
BVQ	Visual pressure indicator with manual reset	316			
Clogging indicators on SUCTION line		page	Clogging indicators on SUCTION line		page
VVB	Axial pressure gauge	313	VEB	Electrical vacuum indicator	312
VVS	Radial pressure gauge	313	VLB	Electrical/visual vacuum indicator	312
Differential indicators		page	Differential indicators		page
DEA	Electrical differential indicator	317	DTA	Electronic differential indicator	320
DEM	Electrical differential indicator	317-318	DVA	Visual differential indicator	320
DLA	Electrical / visual differential indicator	318-319	DVM	Visual differential indicator	320
DLE	Electrical / visual differential indicator	319			

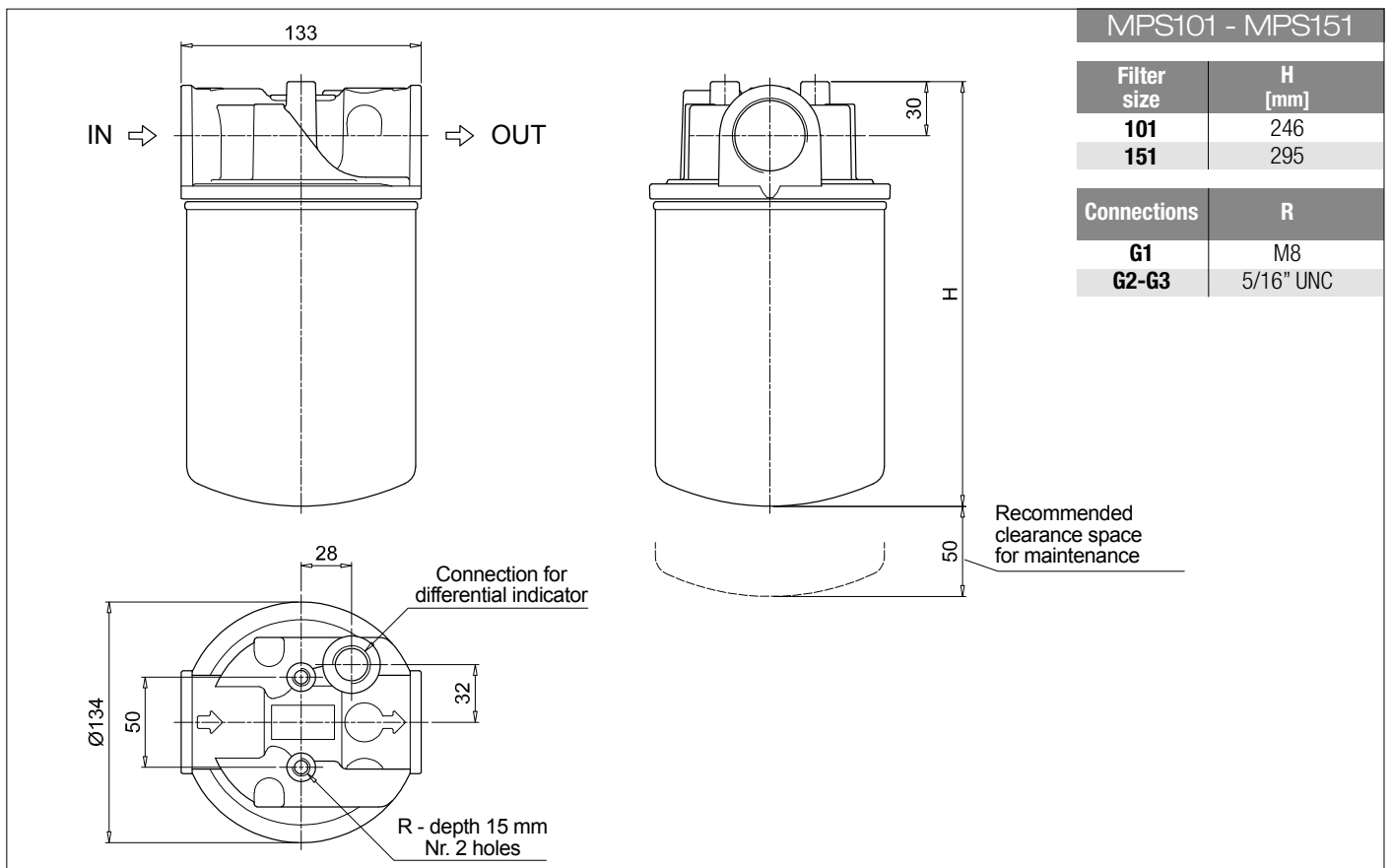
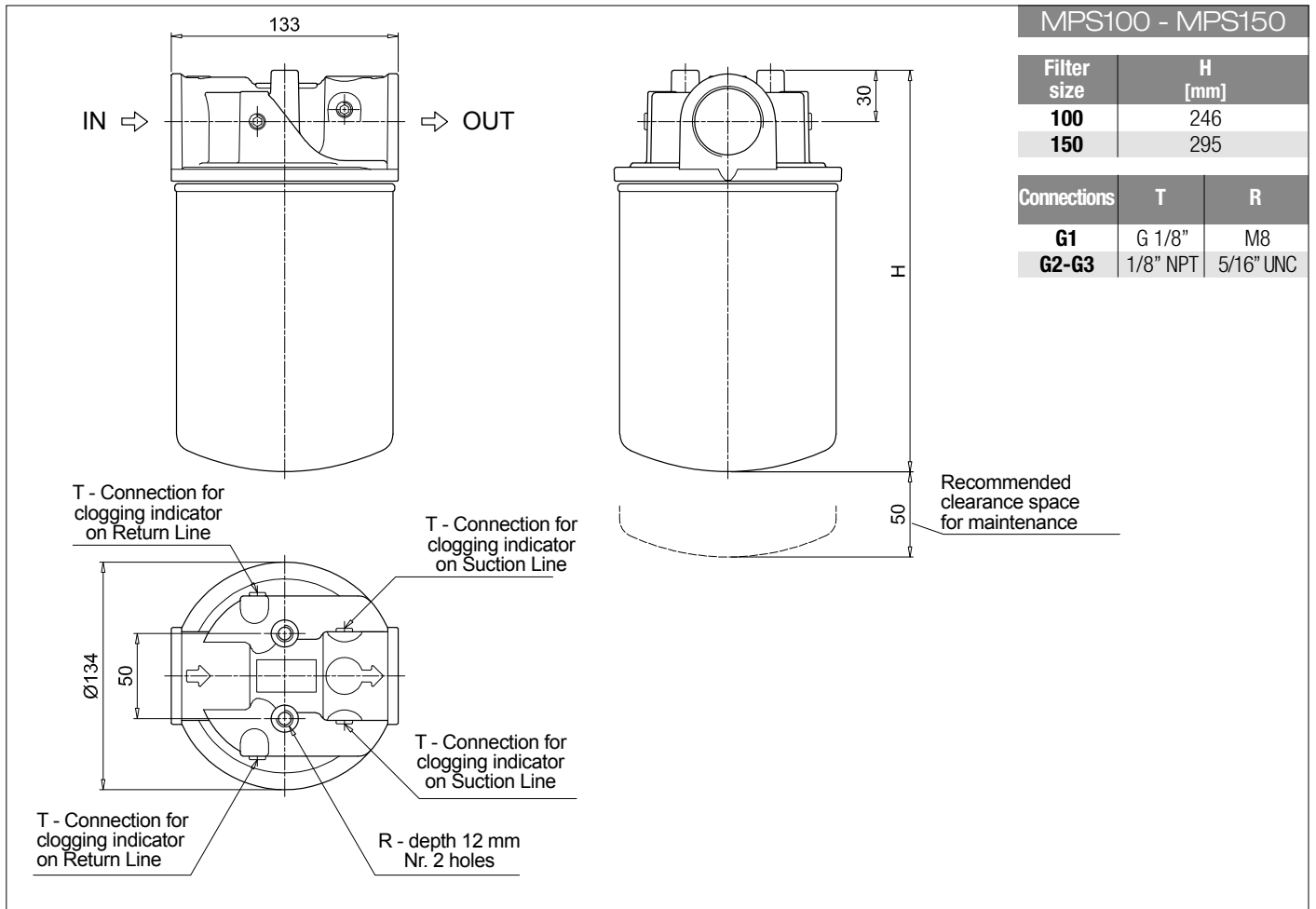

MPS MPS200 - MPS250

Designation & Ordering code

COMPLETE FILTER

Series and size

MPS200 | **MPS250**

Configuration example: **MPS200** **R** **G1** **A10** **A** **P01**

Bypass valve

R Return: 1.75 bar

S Suction: 30 kPa

U Without bypass

Connections

G1 G 1 1/2"

G2 1 1/2" NPT

G3 SAE 24 - 1 7/8" - 12 UN

Filtration rating (filter media)

A03 Inorganic microfiber 3 µm

A06 Inorganic microfiber 6 µm

A10 Inorganic microfiber 10 µm

A25 Inorganic microfiber 25 µm

M25 Wire mesh 25 µm

M60 Wire mesh 60 µm

M90 Wire mesh 90 µm

P10 Resin impregnated paper 10 µm

P25 Resin impregnated paper 25 µm

Seal

A NBR

Execution

P01 MP Filtri standard

CARTRIDGE

Cartridge series and size

CS100 | **CS150**

Configuration example: **CS100** **A10** **A** **P01**

Filtration rating (filter media)

A03 Inorganic microfiber 3 µm

A06 Inorganic microfiber 6 µm

A10 Inorganic microfiber 10 µm

A25 Inorganic microfiber 25 µm

M25 Wire mesh 25 µm

M60 Wire mesh 60 µm

M90 Wire mesh 90 µm

P10 Resin impregnated paper 10 µm

P25 Resin impregnated paper 25 µm

Seals

A NBR

Execution

P01 MP Filtri standard

Pxx Customized

ACCESSORIES

Clogging indicators on RETURN line

BVA Axial pressure gauge 315

BVR Radial pressure gauge 315

BVP Visual pressure indicator with automatic reset 316

BVQ Visual pressure indicator with manual reset 316

BEA Electrical pressure indicator 314

BEM Electrical pressure indicator 314

BLA Electrical / visual pressure indicator 314-315

Clogging indicators on SUCTION line

VVB Axial pressure gauge 313

VVS Radial pressure gauge 313

VEB Electrical vacuum indicator 312

VLB Electrical/visual vacuum indicator 312

MPS200 - MPS250

Filter size	H [mm]
200	213
250	262

Connections	T	R
G1	G 1/8"	M10
G2-G3	1/8" NPT	7/16" UNC

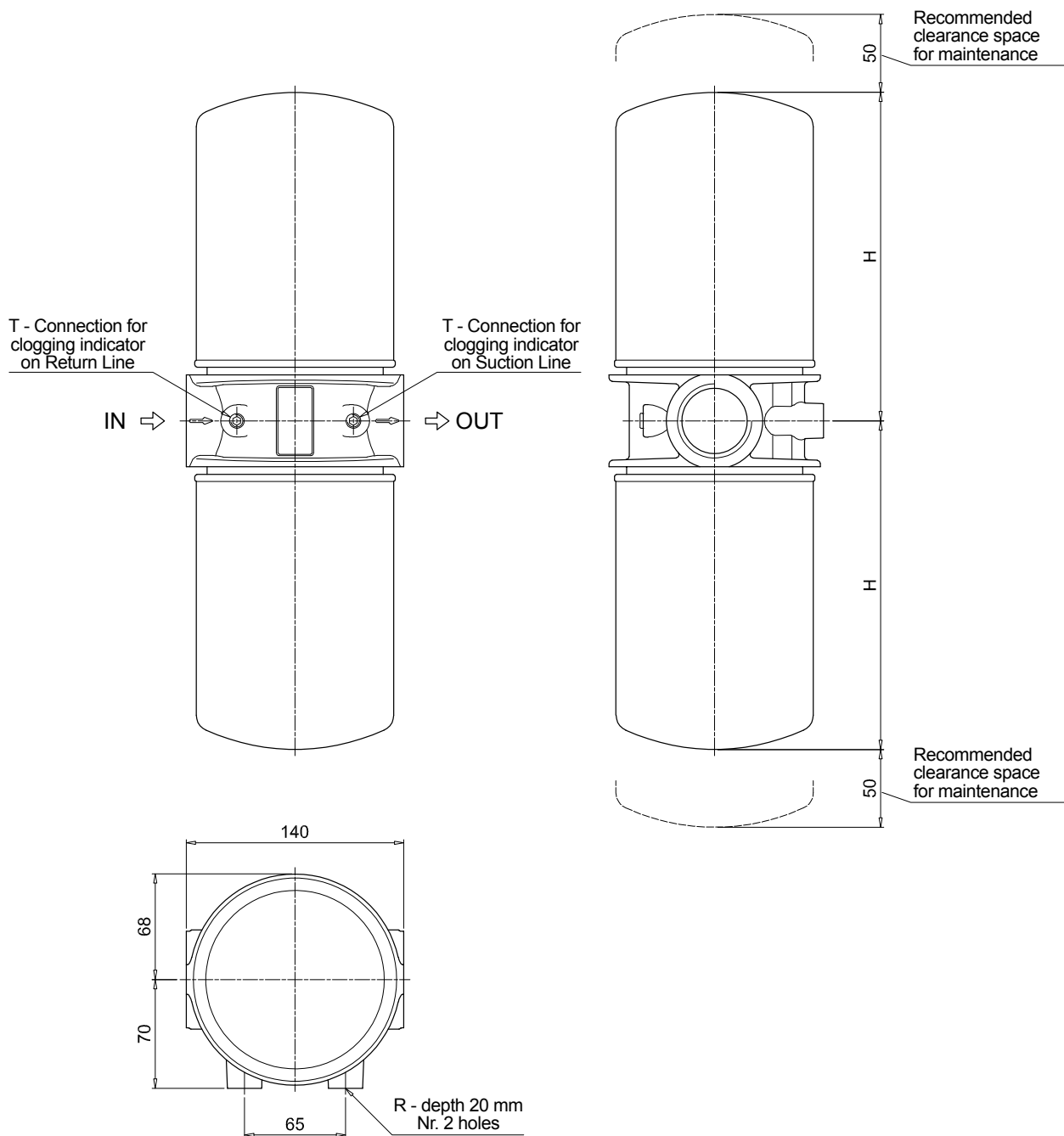

MPS MPS300 - MPS350 MPS301 - MPS351

Designation & Ordering code

COMPLETE FILTER

Series and size

MPS300 | **MPS350** With connections for clogging indicators

MPS301 | **MPS351** With connections for differential indicators

Configuration example: **MPS300** **R** **F1** **A10** **A** **P01**

Bypass valve

	MPS 300 - 350	MPS 301 - 351
R Return: 1.75 bar	•	•
S Suction: 30 kPa	•	
U Without bypass	•	
P Without bypass		•

Connections

G1 G 1 1/2"	
G2 1 1/2" NPT	
G3 SAE 24 - 1 7/8" - 12 UN	
F1 1 1/2" SAE 3000 psi/M	
F2 1 1/2" SAE 3000 psi/UNC	

Filtration rating (filter media)

A03 Inorganic microfiber 3 µm	M25 Wire mesh 25 µm
A06 Inorganic microfiber 6 µm	M60 Wire mesh 60 µm
A10 Inorganic microfiber 10 µm	M90 Wire mesh 90 µm
A25 Inorganic microfiber 25 µm	P10 Resin impregnated paper 10 µm
	P25 Resin impregnated paper 25 µm

Seal
A NBR

Execution
P01 MP Filtri standard

CARTRIDGE

Cartridge series and size

CS100 | **CS150**

Configuration example: **CS100** **A10** **A** **P01**

Filtration rating (filter media)

A03 Inorganic microfiber 3 µm	M25 Wire mesh 25 µm
A06 Inorganic microfiber 6 µm	M60 Wire mesh 60 µm
A10 Inorganic microfiber 10 µm	M90 Wire mesh 90 µm
A25 Inorganic microfiber 25 µm	P10 Resin impregnated paper 10 µm
	P25 Resin impregnated paper 25 µm

Seals
A NBR

Execution
P01 MP Filtri standard
Pxx Customized

ACCESSORIES

Clogging indicators on RETURN line

	page
BVA Axial pressure gauge	315
BVR Radial pressure gauge	315
BVP Visual pressure indicator with automatic reset	316
BVQ Visual pressure indicator with manual reset	316

	page
BEA Electrical pressure indicator	314
BEM Electrical pressure indicator	314
BLA Electrical / visual pressure indicator	314-315

Clogging indicators on SUCTION line

	page
VVB Axial pressure gauge	313
VVS Radial pressure gauge	313

	page
VEB Electrical vacuum indicator	312
VLB Electrical/visual vacuum indicator	312

Differential indicators

	page
DEA Electrical differential indicator	317
DEM Electrical differential indicator	317-318
DLA Electrical / visual differential indicator	318-319
DLE Electrical / visual differential indicator	319

	page
DTA Electronic differential indicator	320
DVA Visual differential indicator	320
DVM Visual differential indicator	320

MPS300 - MPS350

Filter size	H [mm]
300	266
350	315

Connections	T	R
G1	G 1/8"	M10
G2-G3	1/8" NPT	7/16" UNC
F1	G 1/8"	M10
F2	1/8" NPT	7/16" UNC

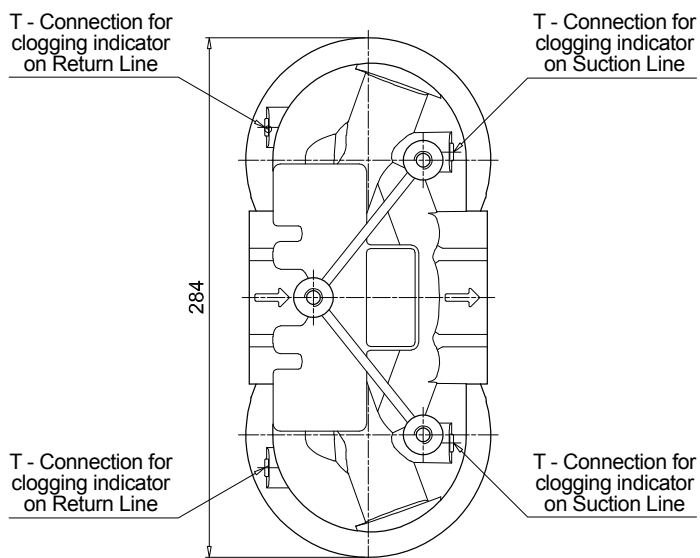
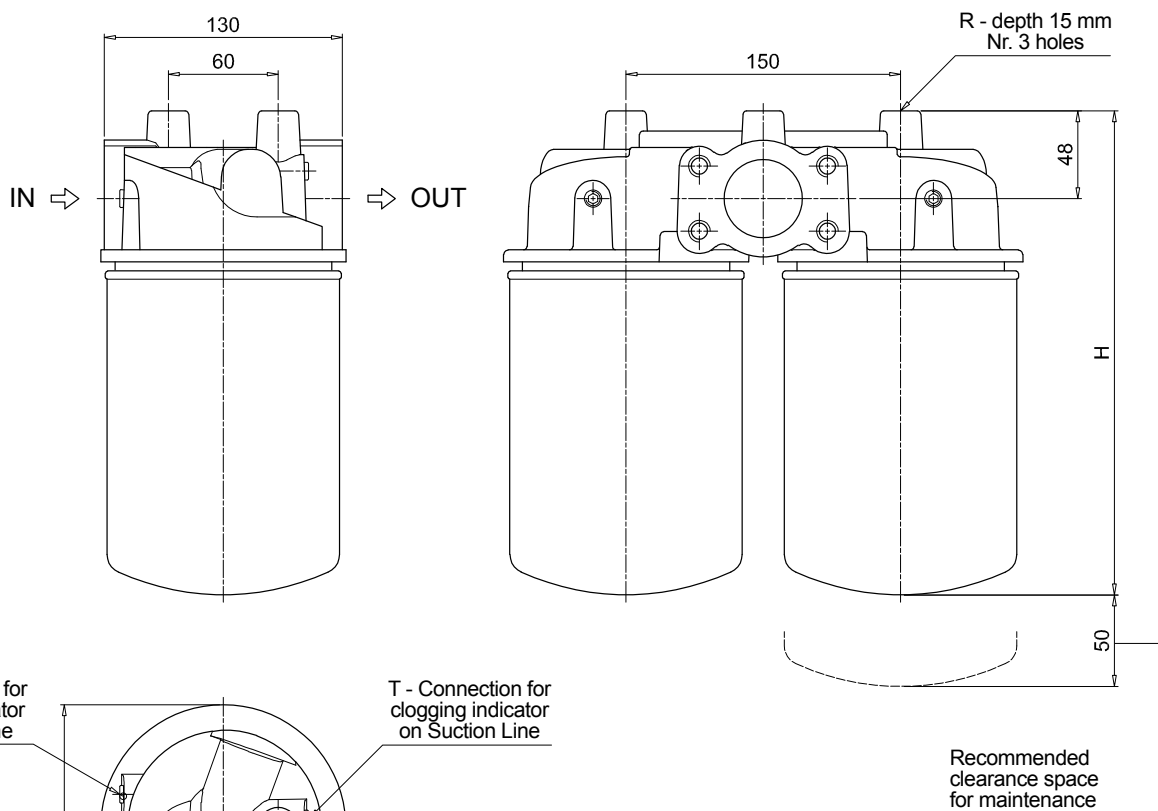

Recommended clearance space for maintenance

MPS MPS300 - MPS350 MPS301 - MPS351

Dimensions

MPS301 - MPS351

Filter size	H [mm]
301	266
351	315

Connections	R
G1	M10
G2-G3	7/16" UNC
F1	M10
F2	7/16" UNC

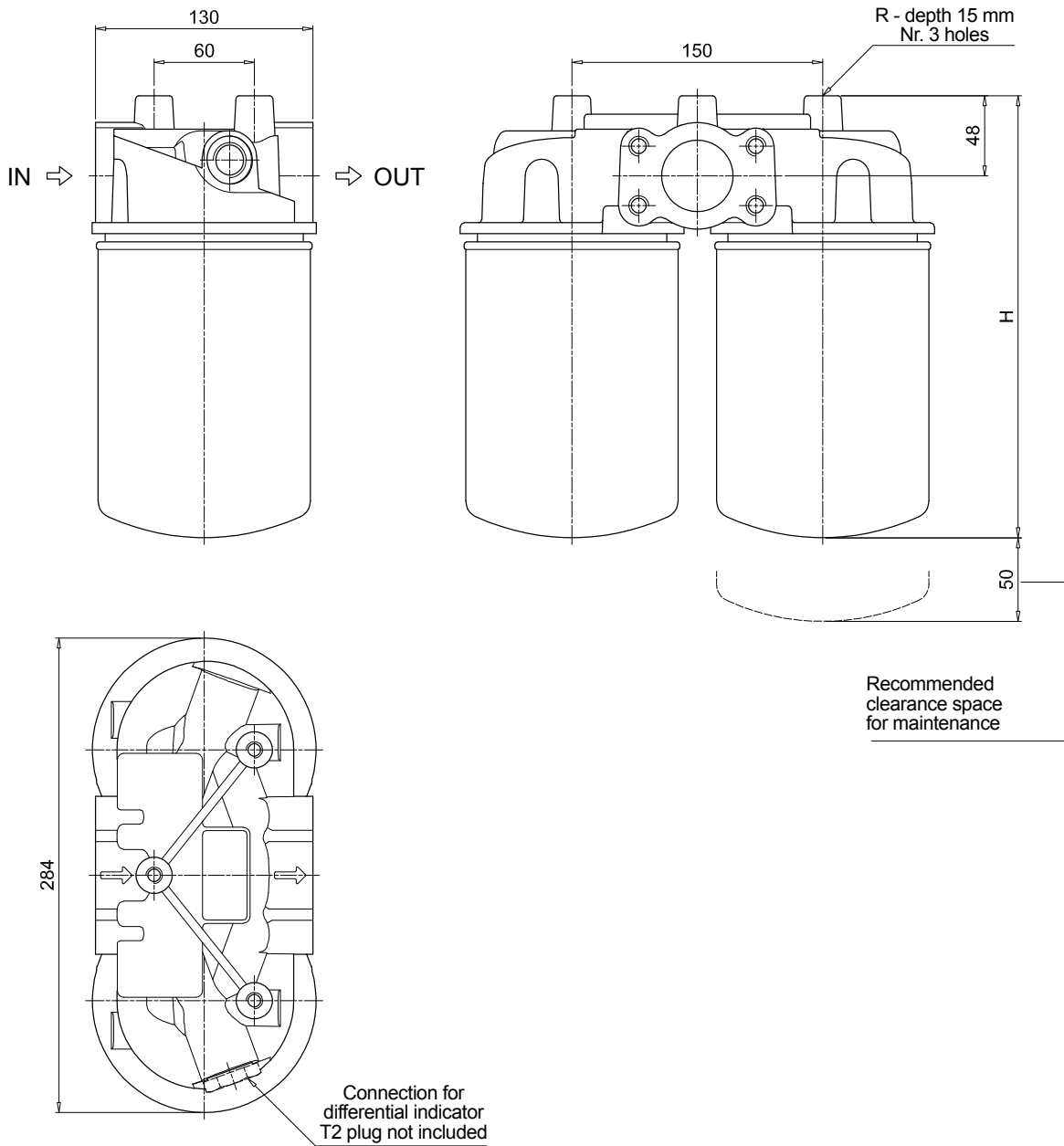

MSH series

Maximum working pressure up to 3.5 MPa (35 bar) - Flow rate up to 195 l/min



Description

Technical data

Spin-on filters

Maximum working pressure up to 3.5 MPa (35 bar)
Flow rate up to 195 l/min

MSH is a range of spin-on filters suitable to be used in low pressure lines. They offer a good balance between performances, dimensions and prices. They are directly connected to the lines of the system through the hydraulic fittings.

Available features:

- Female threaded connections up to 1 1/4", for a maximum flow rate of 195 l/min
- Fine filtration rating, to get a good cleanliness level into the reservoir
- Strong sealing between the housing and cans, to be used in heavy applications
- Bypass valve, to relieve excessive pressure drop across the filter media
- Visual, electrical and electronic differential clogging indicators for low pressure applications

Common applications:

- Delivery lines, in economic industrial equipment or mobile machines

Filter housing materials

- Head: Anodized Aluminium
- Bypass valve: Nylon - Steel
- Element: Aluminium - Painted Steel

Bypass valve

Opening pressure: 250 kPa (2.5 bar) ±10%

Δp element type

- Δp: 5 bar
- Oil flow from OUT to IN

Seals

- Standard NBR - series A
- Optional FPM - series V

Temperature

From -20 °C to +110 °C

Note

MSH filters are provided for vertical mounting



Weights [kg] and volumes [dm³]

Filter series	Weights [kg]	Volumes [dm ³]
MSH 050	1.50	0.65
MSH 070	1.90	0.95
MSH 100	3.30	1.80
MSH 150	3.80	2.20

Cartridge

Thread connections	
Type	Connection
CH 050 - 070	M32 x 2
CH 100 - 150	M45 x 2

CH

Bypass valve pressure drop

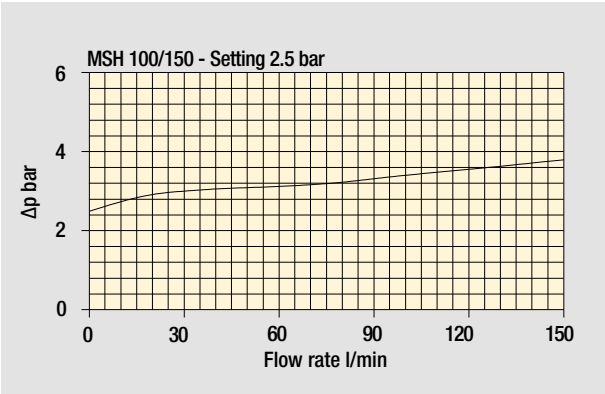
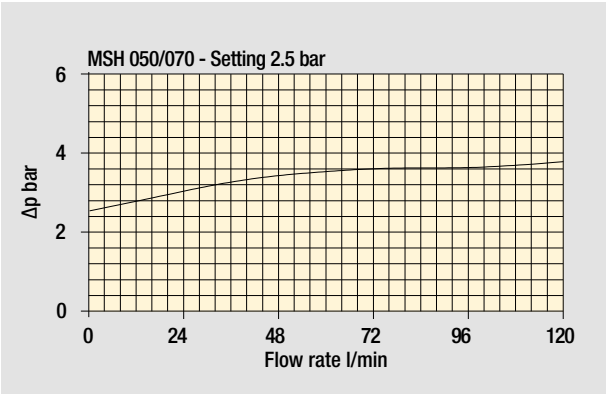

The curves are plotted using mineral oil with density of 0.86 kg/dm³ in compliance with ISO 3968. Δp varies proportionally with density.

Hydraulic symbols

Filter series	Style S	Style B
MSH 050	•	•
MSH 070	•	•
MSH 100	•	•
MSH 150	•	•

OUT

IN

OUT

IN

MSH MSH050 - MSH070 MSH100 - MSH150

Designation & Ordering code

COMPLETE FILTER

Series and size		Configuration example: MSH050 B A G1 A10 P01				
MSH050 MSH070 MSH100 MSH150						
Bypass valve						
S	Without bypass					
B	2.5 bar					
Seal						
A	NBR					
Connections	MSH 050 - 070	MSH 100 - 150				
G1	G 1"	G 1 1/2"				
G2	G 3/4"	G 1 1/4"				
G3	1" NPT	1 1/2" NPT				
G4	3/4" NPT	1 1/4" NPT				
G5	SAE 16 - 1 5/16" - 12 UN	SAE 24 - 1 7/8" - 12 UN				
G6	SAE 12 - 1 1/16" - 12 UN	SAE 20 - 1 5/8" - 12 UN				
Filtration rating (filter media)						
A03	Inorganic microfiber 3 µm	M25	Wire mesh 25 µm			
A06	Inorganic microfiber 6 µm	M60	Wire mesh 60 µm			
A10	Inorganic microfiber 10 µm	M90	Wire mesh 90 µm			
A25	Inorganic microfiber 25 µm	P10	Resin impregnated paper 10 µm			
		P25	Resin impregnated paper 25 µm			
				Execution		
				P01 MP Filtri standard		

CARTRIDGE

Cartridge series and size		Configuration example: CH050 A10 A P01			
CH050 CH070 CH100 CH150					
Filtration rating (filter media)					
A03	Inorganic microfiber 3 µm	M25	Wire mesh 25 µm		
A06	Inorganic microfiber 6 µm	M60	Wire mesh 60 µm		
A10	Inorganic microfiber 10 µm	M90	Wire mesh 90 µm		
A25	Inorganic microfiber 25 µm	P10	Resin impregnated paper 10 µm		
		P25	Resin impregnated paper 25 µm		
		Seal		Execution	
		A NBR		P01 MP Filtri standard	
				Pxx Customized	

ACCESSORIES

Differential indicators	page		page
DEA Electrical differential indicator	317	DTA Electronic differential indicator	320
DEM Electrical differential indicator	317-318	DVA Visual differential indicator	320
DLA Electrical / visual differential indicator	318-319	DVM Visual differential indicator	320
DLE Electrical / visual differential indicator	319		

Additional features	page
T2 Plug	321

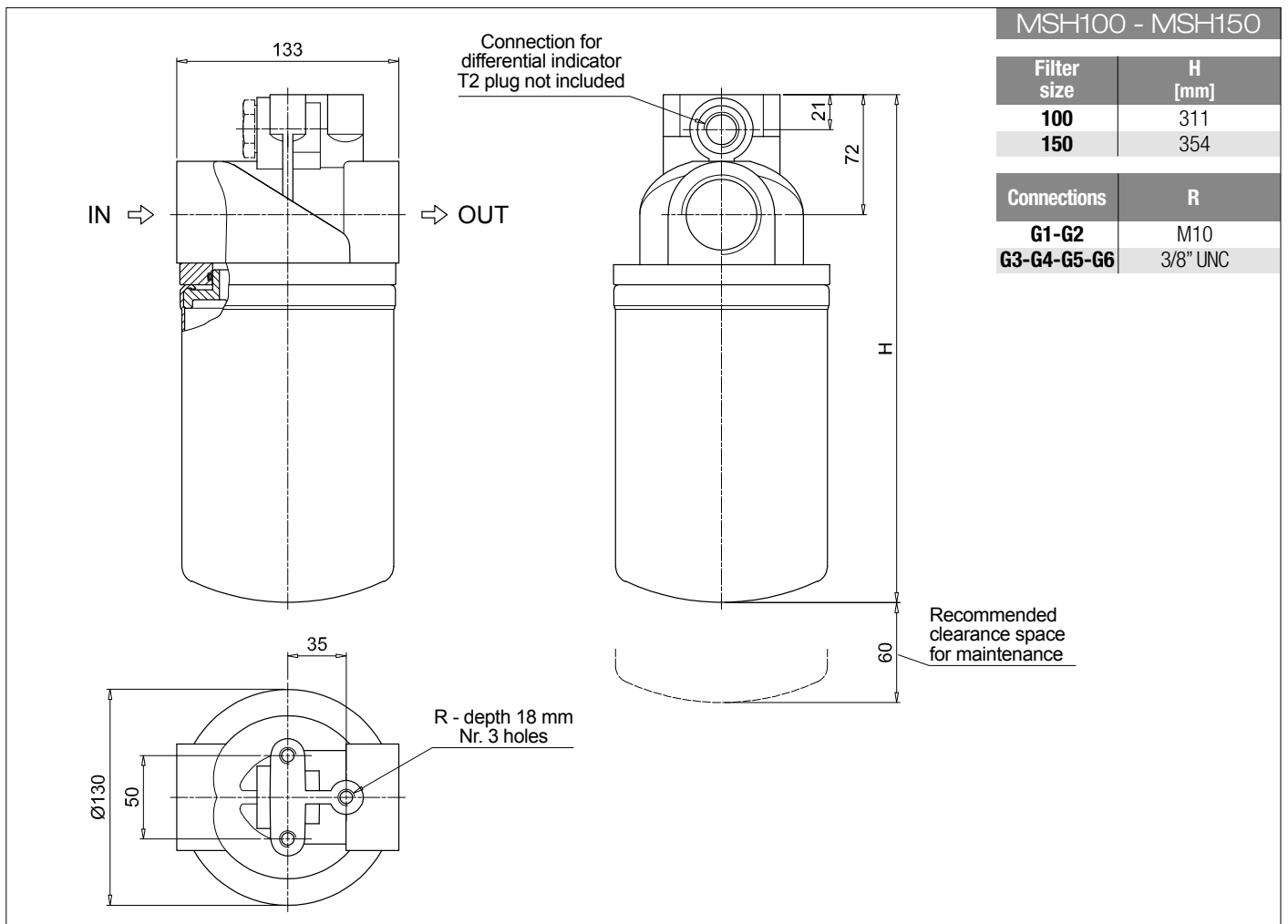
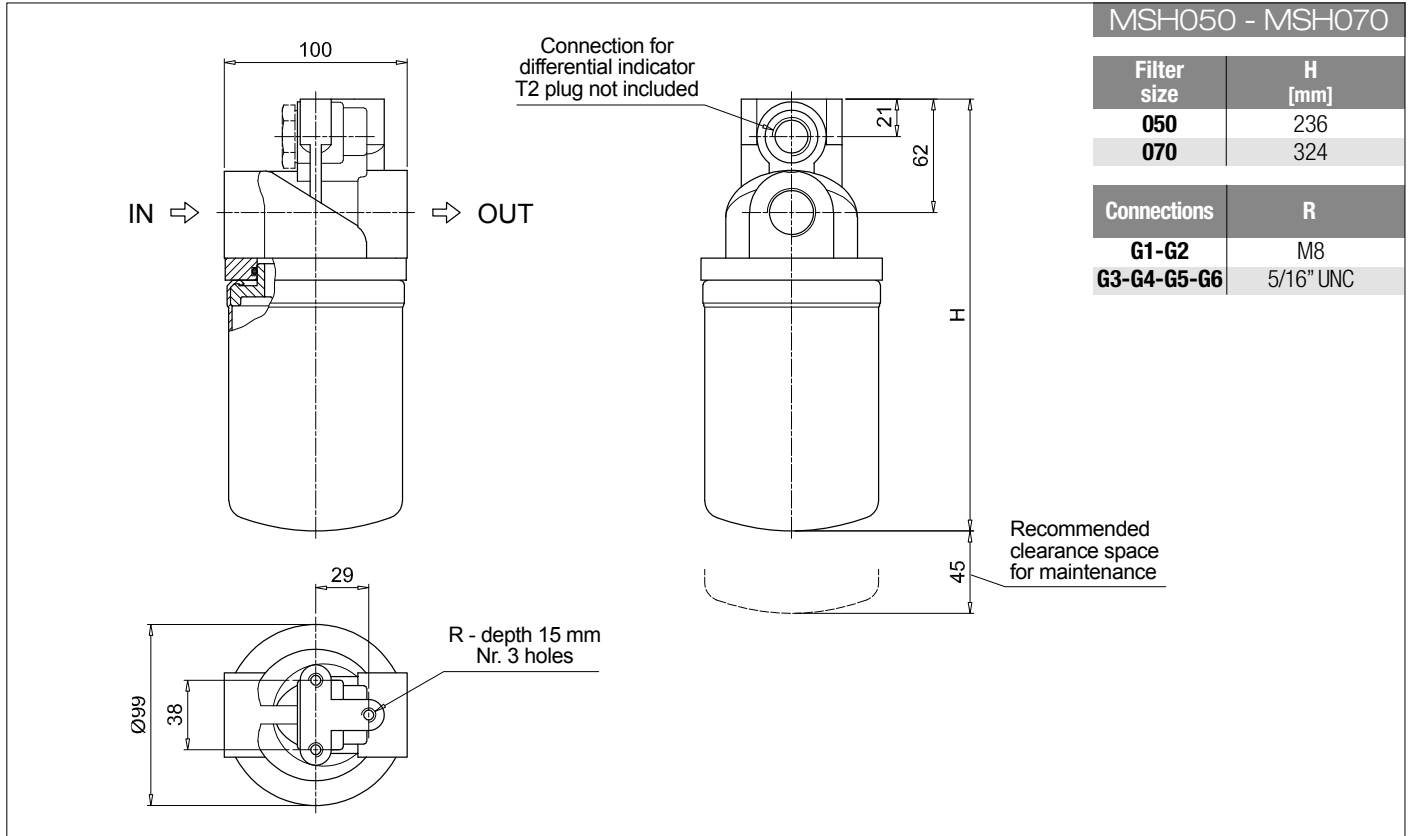

MSH SPARE PARTS

Order number for spare parts

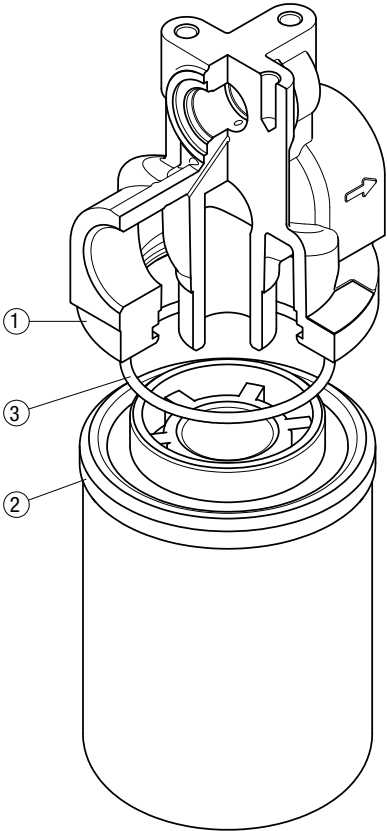

Item:	Q.ty: 1 pc. 1	Q.ty: 1 pc. 2	Q.ty: 1 pc. 3
Filter series	Filter assembly	Cartridge	Seal code number
MSH 050-070	See order table	See order table	0-R 167 (ø 63.50 x 3.53)
MSH 100-150	See order table	See order table	0-R 4362 (ø 91.67 x 3.53)

Clogging indicators

Introduction

Filter elements are efficient only if their Dirt Holding Capacity is fully exploited. This is achieved by using filter housings equipped with clogging indicators. These devices trip when the clogging of the filter element causes an increase in pressure drop across the filter element.

The indicator is set to alarm before the element becomes fully clogged.

MP Filtri can supply indicators of the following designs:

- Vacuum switches and gauges
- Pressure switches and gauges
- Differential pressure indicators

These type of devices can be provided with a visual, electrical or both signals.

Barometric indicators
Vacuum indicators
Differential indicators

Suitable indicator types

VACUUM INDICATORS

Vacuum indicators are used on the Suction line to check the efficiency of the filter element.

They measure the pressure downstream of the filter element. Standard items are produced with R 1/4" EN 10226 connection. Available products with R 1/8" EN 10226 to be fitted on MPS series.

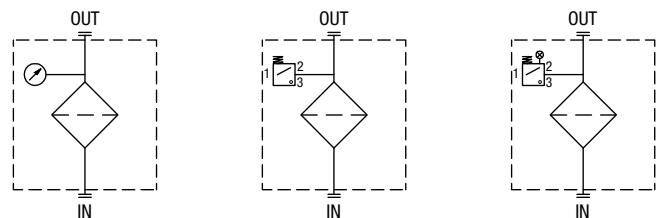

BAROMETRIC INDICATORS

Pressure indicators are used on the Return line to check the efficiency of the filter element.

They measure the pressure upstream of the filter element. Standard items are produced with R 1/8" EN 10226 connection.

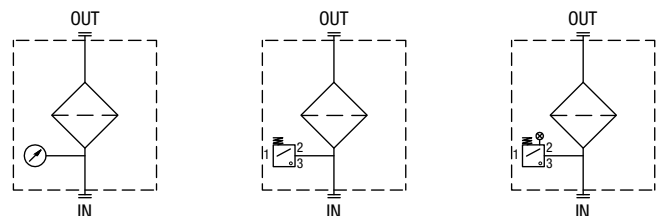

DIFFERENTIAL INDICATORS

Differential indicators are used on the Pressure line to check the efficiency of the filter element.

They measure the pressure upstream and downstream of the filter element (differential pressure). Standard items are produced with special connection G 1/2" size. Also available in Stainless Steel models.

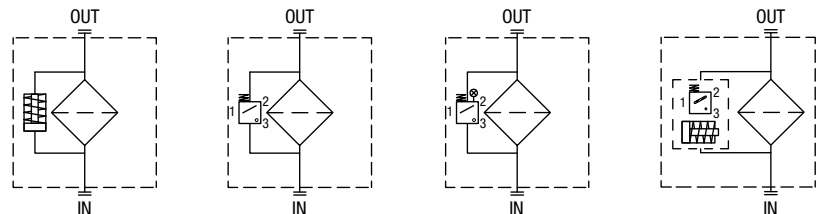

Quick reference guide

	Filter series	Visual indicator	Electrical indicator	Electrical / Visual indicator
Suction line	MPS 050 - 070 - 100 - 150 MPS 200 - 250 - 300 - 350	WB16P01 VVS16P01	VEB21AA50P01	VLB21AA51P01 VLB21AA52P01 VLB21AA53P01 VLB21AA71P01
Return line	MPS 050 - 070 - 100 - 150 MPS 200 - 250 - 300 - 350	BVA14P01 BVR14P01 BVP20HP01 BVQ20HP01	BEA15HA50P01 BEM15HA41P01	BLA15HA51P01 BLA15HA52P01 BLA15HA53P01 BLA15HA71P01
In-line	MPS 051 - 071 - 101 - 151 MPS 301 - 351 MSH 050 - 070 - 100 - 150	DVA12xP01 DVM12xP01	DEA12xA50P01 DEM12xAxxP01	DLA12xA51P01 DLA12xA52P01 DLA12xA71P01 DLE12xA50P01 DLE12xF50P01

VACUUM INDICATORS

Dimensions

VE*50	
Electrical Vacuum Indicator	
R	Ordering code
EN 10226 - R1/8"	VE B 21 A A 50 P01
<p>Hydraulic symbol</p>	
<p>Electrical symbol</p>	
<p>Materials</p> <ul style="list-style-type: none"> - Body: Brass - Base: Black Nylon - Contacts: Silver - Seal: NBR 	
<p>Technical data</p> <ul style="list-style-type: none"> - Vacuum setting: -0.21 bar ±10% - Max working pressure: 10 bar - Proof pressure: 15 bar - Working temperature: From -25 °C to +80 °C - Compatibility with fluids: Mineral oils, Synthetic fluids HFA, HFB, HFC according to ISO 2943 - Degree of protection: IP65 according to EN 60529 	
<p>Electrical data</p> <ul style="list-style-type: none"> - Electrical connection: EN 175301-803 - Resistive load: 5 A / 14 Vdc 4 A / 30 Vdc 5 A / 125 Vac 4 A / 250 Vac - Available Atex product: II 1GD Ex ia IIC Tx Ex ia IIIC Tx°C X - CE certification 	

VL*51 - VL*52 - VL*53	
Electrical/Visual Vacuum Indicator	
R	Ordering code
EN 10226 - R1/8"	VL B 21 A A xx P01
<p>Hydraulic symbol</p>	
<p>Electrical symbol</p>	
<p>Materials</p> <ul style="list-style-type: none"> - Body: Brass - Base: Transparent Nylon - Contacts: Brass - Nylon - Seal: NBR 	
<p>Technical data</p> <ul style="list-style-type: none"> - Vacuum setting: -0.21 bar ±10% - Max working pressure: 10 bar - Proof pressure: 15 bar - Working temperature: From -25 °C to +80 °C - Compatibility with fluids: Mineral oils, Synthetic fluids HFA, HFB, HFC according to ISO 2943 - Degree of protection: IP65 according to EN 60529 	
<p>Electrical data</p> <ul style="list-style-type: none"> - Electrical connection: EN 175301-803 - Type: 51 52 53 - Lamps: 24 Vdc 110 Vdc 230 Vac - Resistive load: 1 A / 24 Vdc 1 A / 110 Vdc 1 A / 230 Vac 	

VL*71	
Electrical/Visual Vacuum Indicator	
Connections	Ordering code
EN 10226 - R1/8"	VL B 21 A A 71 P01
<p>Hydraulic symbol</p>	
<p>Electrical symbol</p>	
<p>Materials</p> <ul style="list-style-type: none"> - Body: Brass - Base: Black Nylon - Contacts: Silver - Seal: NBR 	
<p>Technical data</p> <ul style="list-style-type: none"> - Vacuum setting: -0.21 bar ±10% - Max working pressure: 10 bar - Proof pressure: 15 bar - Working temperature: From -25 °C to +80 °C - Compatibility with fluids: Mineral oils, Synthetic fluids HFA, HFB, HFC according to ISO 2943 - Degree of protection: IP65 according to EN 60529 	
<p>Electrical data</p> <ul style="list-style-type: none"> - Electrical connection: IEC 61076-2-101 D (M12) - Lamps: 24 Vdc - Resistive load: 0.4 A / 24 Vdc 	

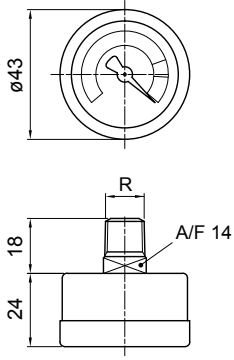
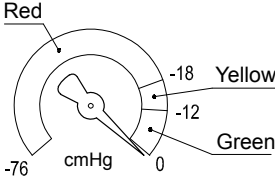
WB		Hydraulic symbol	Materials								
Axial Vacuum Gauge											
R	Ordering code		- Case: Painted Steel - Window: Transparent plastic - Dial: Painted Steel - Pointer: Painted Aluminium - Pressure connection: Brass - Pressure element: Bourdon tube Cu-alloy soft soldered								
EN 10226 - R1/8"	WB B 16 P01										
		Dial scale 	Technical data - Max working pressure: Static: 7 bar Fluctuating: 6 bar Short time: 10 bar - Working temperature: From -40 °C to +60 °C - Compatibility with fluids: Mineral oils, Synthetic fluids HFA, HFB, HFC according to ISO 2943 - Accuracy: Class 2.5 according to EN 13190 - Degree of protection: IP65 according to EN 60529								
		Conversion to SI units <table border="1"> <thead> <tr> <th>[cmHg]</th> <th>[bar]</th> </tr> </thead> <tbody> <tr> <td>-12</td> <td>-0.16</td> </tr> <tr> <td>-18</td> <td>-0.24</td> </tr> <tr> <td>-76</td> <td>-1.01</td> </tr> </tbody> </table>	[cmHg]	[bar]	-12	-0.16	-18	-0.24	-76	-1.01	
[cmHg]	[bar]										
-12	-0.16										
-18	-0.24										
-76	-1.01										

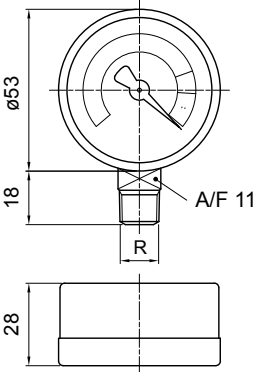
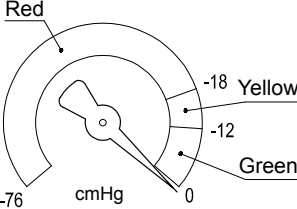
WS		Hydraulic symbol	Materials								
Radial Vacuum Gauge											
R	Ordering code		- Case: Painted Steel - Window: Transparent plastic - Dial: Painted Steel - Pointer: Painted Aluminium - Pressure connection: Brass - Pressure element: Bourdon tube Cu-alloy soft soldered								
EN 10226 - R1/8"	WS S 16 P01										
		Dial scale 	Technical data - Max working pressure: Static: 7 bar Fluctuating: 6 bar Short time: 10 bar - Working temperature: From -40 °C to +60 °C - Compatibility with fluids: Mineral oils, Synthetic fluids HFA, HFB, HFC according to ISO 2943 - Accuracy: Class 2.5 according to EN 13190 - Degree of protection: IP65 according to EN 60529								
		Conversion to SI units <table border="1"> <thead> <tr> <th>[cmHg]</th> <th>[bar]</th> </tr> </thead> <tbody> <tr> <td>-12</td> <td>-0.16</td> </tr> <tr> <td>-18</td> <td>-0.24</td> </tr> <tr> <td>-76</td> <td>-1.01</td> </tr> </tbody> </table>	[cmHg]	[bar]	-12	-0.16	-18	-0.24	-76	-1.01	
[cmHg]	[bar]										
-12	-0.16										
-18	-0.24										
-76	-1.01										

DESIGNATION & ORDERING CODE									
Series		Configuration example 1:	VE	B	21	A	A	50	P01
VE	Electrical vacuum indicator	Configuration example 2:	VL	B	21	A	A	71	P01
VL	Electrical/Visual vacuum indicator	Configuration example 3:	WV	S	16				P01
VV	Vacuum gauge								
Type VE - VL		Type WV							
B	Connection EN 10226 - R1/8"	B	Axial connection EN 10226 - R1/8"						
		S	Radial connection EN 10226 - R1/8"						
Vacuum setting		VE	VL	VV					
16	0.16 bar			•					
21	0.21 bar	•	•						
Seals		VE	VL	VV					
A	NBR	•	•						
Thermostat		VE	VL	VV					
A	Without	•	•						
Electrical connections		VE	VL	VV					
50	Connection EN 175301-803	•							
51	Connection EN 175301-803, transparent base with lamps 24 Vdc		•						
52	Connection EN 175301-803, transparent base with lamps 110 Vdc		•						
53	Connection EN 175301-803, transparent base with lamps 230 Vdc		•						
71	Connection IEC 61076-2-101 D (M12), black base with lamps 24 Vdc		•						
									Option
									P01 MP Filtri standard
									Pxx Customized

BAROMETRIC INDICATORS

Dimensions

BEA*50	
Electrical Pressure Indicator	
Settings	Ordering code
1.5 bar ±10%	BE A 15 H A 50 P01
2 bar ±10%	BE A 20 H A 50 P01

Hydraulic symbol

Electrical symbol

Materials

- Body: Brass
- Base: Black Nylon
- Contacts: Silver
- Seal: HNBR

Technical data

- Max working pressure: 40 bar
- Proof pressure: 60 bar
- Working temperature: From -25 °C to +80 °C
- Compatibility with fluids: Mineral oils, Synthetic fluids
HFA, HFB, HFC according to ISO 2943
- Degree of protection: IP65 according to EN 60529

Electrical data

- Electrical connection: EN 175301-803
- Resistive load: 5 A / 14 Vdc
4 A / 30 Vdc
5 A / 125 Vac
4 A / 250 Vac

- Available Atex product: II 1GD Ex ia IIC Tx Ex ia IIIC Tx°C X

- CE certification

BEM*41	
Electrical Pressure Indicator	
Settings	Ordering code
1.5 bar ±10%	BE M 15 H A 41 P01
2 bar ±10%	BE M 20 H A 41 P01

Hydraulic symbol

Electrical symbol

Materials

- Body: Brass
- Base: Black Nylon
- Contacts: Silver
- Seal: HNBR

Technical data

- Max working pressure: 40 bar
- Proof pressure: 60 bar
- Working temperature: From -25 °C to +80 °C
- Compatibility with fluids: Mineral oils, Synthetic fluids
HFA, HFB, HFC according to ISO 2943
- Degree of protection: IP67 according to EN 60529

Electrical data

- Electrical connection: Four-core cable
- Resistive load: 5 A / 14 Vdc
4 A / 30 Vdc
5 A / 125 Vac
4 A / 250 Vac

- CE certification
On request this indicator can be provided with main connectors in use for wirings.

BL*51 - BL*52 - BL*53	
Electrical/Visual Pressure Indicator	
Settings	Ordering code
1.5 bar ±10%	BL A 15 H A xx P01
2 bar ±10%	BL A 20 H A xx P01

Hydraulic symbol

Electrical symbol

Materials

- Body: Brass
- Base: Transparent Nylon
- Contacts: Silver
- Seal: HNBR

Technical data

- Max working pressure: 40 bar
- Proof pressure: 60 bar
- Working temperature: From -25 °C to +80 °C
- Compatibility with fluids: Mineral oils, Synthetic fluids
HFA, HFB, HFC according to ISO 2943
- Degree of protection: IP65 according to EN 60529

Electrical data

- Electrical connection: EN 175301-803
- Type: 51 52 53
- Lamps: 24 Vdc 110 Vdc 230 Vac
- Resistive load: 1 A / 24 Vdc 1 A / 110 Vdc 1 A / 230 Vac

BL*71	
Electrical/Visual Pressure Indicator	
Settings	Ordering code
1.5 bar $\pm 10\%$	BL A 15 HA 71 P01
2 bar $\pm 10\%$	BL A 20 HA 71 P01

Hydraulic symbol

Electrical symbol

Materials

- Body: Brass
- Base: Black Nylon
- Contacts: Silver
- Seal: HNBR

Technical data

- Max working pressure: 40 bar
- Proof pressure: 60 bar
- Working temperature: From -25 °C to +80 °C
- Compatibility with fluids: Mineral oils, Synthetic fluids HFA, HFB, HFC according to ISO 2943
- Degree of protection: IP65 according to EN 60529

Electrical data

- Electrical connection: IEC 61076-2-101 D (M12)
- Lamps: 24 Vdc
- Resistive load: 0.4 A / 24 Vdc

BVA	
Axial Pressure Gauge	
Settings	Ordering code
1.4 bar $\pm 10\%$	BV A 14 P01
2.5 bar $\pm 10\%$	BV A 25 P01

Hydraulic symbol

Dial scale

BV A 14 P01

BV A 25 P01

Materials

- Case: Painted Steel
- Window: Transparent plastic
- Dial: Painted Steel
- Pointer: Painted Aluminium
- Pressure connection: Brass
- Pressure element: Bourdon tube Cu-alloy soft soldered

Technical data

- Max working pressure: Static: 7 bar
Fluctuating: 6 bar
Short time: 10 bar
- Working temperature: From -40 °C to +60 °C
- Compatibility with fluids: Mineral oils, Synthetic fluids HFA, HFB, HFC according to ISO 2943
- Accuracy: Class 2.5 according to EN 13190
- Degree of protection: IP31 according to EN 60529

BVR	
Radial Pressure Gauge	
Settings	Ordering code
1.4 bar $\pm 10\%$	BV R 14 P01
2.5 bar $\pm 10\%$	BV R 25 P01

Hydraulic symbol

Dial scale

BV R 14 P01

BV R 25 P01

Materials

- Case: Painted Steel
- Window: Transparent plastic
- Dial: Painted Steel
- Pointer: Painted Aluminium
- Pressure connection: Brass
- Pressure element: Bourdon tube Cu-alloy soft soldered

Technical data

- Max working pressure: Static: 7 bar
Fluctuating: 6 bar
Short time: 10 bar
- Working temperature: From -40 °C to +60 °C
- Compatibility with fluids: Mineral oils, Synthetic fluids HFA, HFB, HFC according to ISO 2943
- Accuracy: Class 2.5 according to EN 13190
- Degree of protection: IP31 according to EN 60529

BAROMETRIC INDICATORS

Dimensions

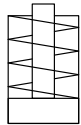
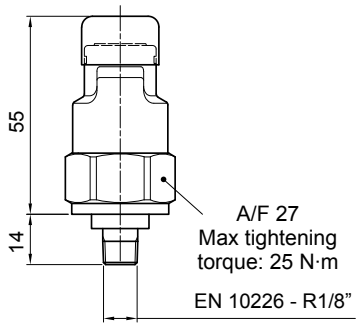
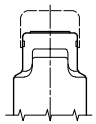
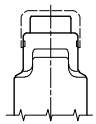
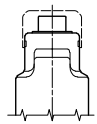
BVP - BVQ		Hydraulic symbol	Materials	
Visual Pressure Indicator				
Setting	Ordering code			
1.5 bar ±10%	BV P 15 H P01 BV Q 15 H P01		Technical data - Reset: BVP - Automatic reset BVQ - Manual reset - Max working pressure: 10 bar - Proof pressure: 15 bar - Working temperature: From -25 °C to +80 °C - Compatibility with fluids: Mineral oils, Synthetic fluids HFA, HFB, HFC according to ISO 2943 - Degree of protection: IP45 according to EN 60529	
2 bar ±10%	BV P 20 H P01 BV Q 20 H P01			
		Signals		
		 Absence of pressure (no indicator)	 Presence of pressure (green button rises gradually)	 Clogged filter element (red button risen)

DESIGNATION & ORDERING CODE

Series
BE Electrical pressure indicator
BL Electrical/Visual pressure indicator
BV Visual pressure indicator

Configuration example 1:	BE	M	15	H	A	41	P01
Configuration example 2:	BL	A	20	H	A	71	P01
Configuration example 3:	BV	R	14				P01
Configuration example 4:	BV	P	20	H			P01

Type	BE	BL	BV
A Standard type	•	•	A Axial connection pressure gauge
M With wired electrical connection	•		R Radial connection pressure gauge
			P Visual indicator with automatic reset
			Q Visual indicator with manual reset

Pressure setting	BEA-BEM	BLA	BVA-BVR	BVP-BVQ
14 1.4 bar			•	
15 1.5 bar	•	•		
20 2 bar	•	•		•
25 2.5 bar			•	

Seals	BE	BLA	BVA-BVR	BVP-BVQ
H HNBR	•	•		•

Thermostat	BEA-BEM	BLA	BV
A Without	•	•	

Electrical connections	BEA	BEM	BL	BV
10 Connection AMP Superseal series 1.5				
30 Connection Deutsch DT-04-2-P				
41 Connection via four-core cable		•		
50 Connection EN 175301-803	•			
51 Connection EN 175301-803, transparent base with lamps 24 Vdc			•	
52 Connection EN 175301-803, transparent base with lamps 110 Vdc			•	
53 Connection EN 175301-803, transparent base with lamps 230 Vdc			•	
71 Connection IEC 61076-2-101 D (M12), black base with lamps 24 Vdc			•	

Option
P01 MP Filtri standard
Pxx Customized

DEA*50	
Electrical Differential Indicator	
Settings	Ordering code
1.2 bar $\pm 10\%$	DE A 12 x A 50 P01
2 bar $\pm 10\%$	DE A 20 x A 50 P01

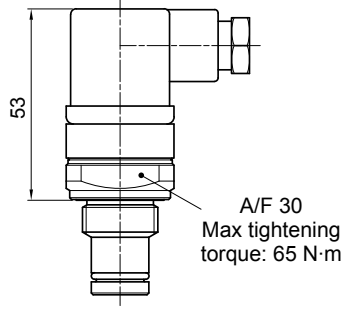

Hydraulic symbol

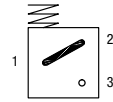

Electrical symbol

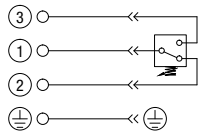

Materials

- Body: Brass
- Base: Black Nylon
- Contacts: Silver
- Seal: HNBR - FPM

Technical data

- Max working pressure: 420 bar
- Proof pressure: 630 bar
- Burst pressure: 1260 bar
- Working temperature: From -25 °C to +110 °C
- Compatibility with fluids: Mineral oils, Synthetic fluids
HFA, HFB, HFC according to ISO 2943
- Degree protection: IP66 according to EN 60529
IP69K according to ISO 20653

Electrical data

- Electrical connection: EN 175301-803
- Resistive load: 0.2 A / 115 Vdc

DEM*10	
Electrical Differential Indicator	
Settings	Ordering code
1.2 bar $\pm 10\%$	DE M 12 x x 10 P01
2 bar $\pm 10\%$	DE M 20 x x 10 P01

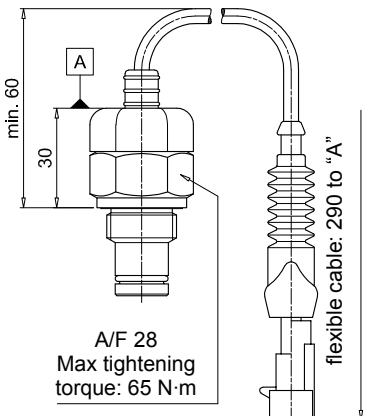

Hydraulic symbol

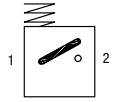

Electrical symbol

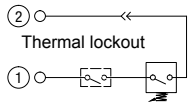

Materials

- Body: Brass
- Base: Black Nylon
- Contacts: Silver
- Seal: HNBR - FPM

Technical data

- Max working pressure: 420 bar
- Proof pressure: 630 bar
- Burst pressure: 1260 bar
- Working temperature: From -25 °C to +110 °C
- Compatibility with fluids: Mineral oils, Synthetic fluids
HFA, HFB, HFC according to ISO 2943
- Degree protection: IP66 according to EN 60529

Electrical data

- Electrical connection: AMP Superseal series 1.5
- Resistive load: 0.2 A / 115 Vdc
- Switching type: Normally open contacts (NC on request)
- Thermal lockout: Normally open up to 30 °C (option "F")

DEM*20	
Electrical Differential Indicator	
Settings	Ordering code
1.2 bar $\pm 10\%$	DE M 12 x x 20 P01
2 bar $\pm 10\%$	DE M 20 x x 20 P01

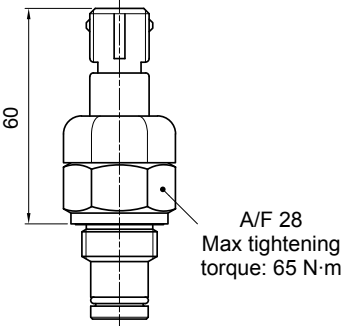

Hydraulic symbol

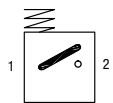

Electrical symbol

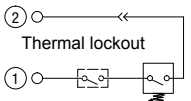

Materials

- Body: Brass
- Base: Black Nylon
- Contacts: Silver
- Seal: HNBR - FPM

Technical data

- Max working pressure: 420 bar
- Proof pressure: 630 bar
- Burst pressure: 1260 bar
- Working temperature: From -25 °C to +110 °C
- Compatibility with fluids: Mineral oils, Synthetic fluids
HFA, HFB, HFC according to ISO 2943
- Degree protection: IP66 according to EN 60529

Electrical data

- Electrical connection: AMP Time junior
- Resistive load: 0.2 A / 115 Vdc
- Switching type: Normally open contacts (NC on request)
- Thermal lockout: Normally open up to 30 °C (option "F")

DIFFERENTIAL INDICATORS

Dimensions

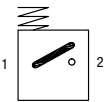
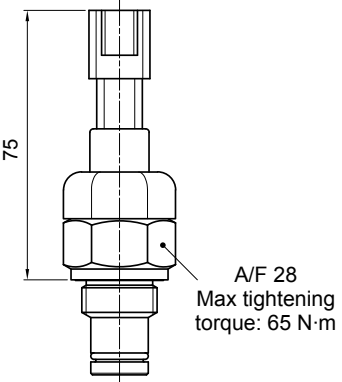
DEM*30		<p>Hydraulic symbol</p> 	<p>Materials</p> <ul style="list-style-type: none"> - Body: Brass - Base: Black Nylon - Contacts: Silver - Seal: HNBR - FPM <p>Technical data</p> <ul style="list-style-type: none"> - Max working pressure: 420 bar - Proof pressure: 630 bar - Burst pressure: 1260 bar - Working temperature: From -25 °C to +110 °C - Compatibility with fluids: Mineral oils, Synthetic fluids - Degree protection: IP66 according to EN 60529 <p>Electrical data</p> <ul style="list-style-type: none"> - Electrical connection: Deutsch DT-04-2-P - Resistive load: 0.2 A / 115 Vdc - Switching type: Normally open contacts (NC on request) - Thermal lockout: Normally open up to 30 °C (option "F")
Electrical Differential Indicator			
Settings	Ordering code		
1.2 bar ±10%	DE M 12 x x 30 P01		
2 bar ±10%	DE M 20 x x 30 P01		
			

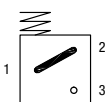
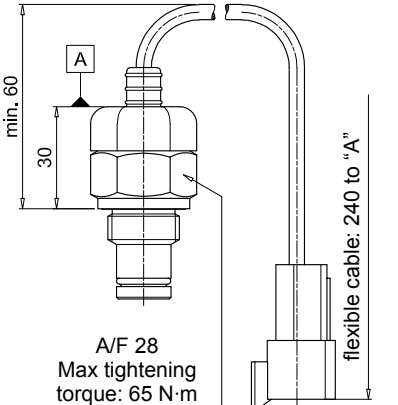
DEM*35		<p>Hydraulic symbol</p> 	<p>Materials</p> <ul style="list-style-type: none"> - Body: Brass - Base: Black Nylon - Contacts: Silver - Seal: HNBR - FPM <p>Technical data</p> <ul style="list-style-type: none"> - Max working pressure: 420 bar - Proof pressure: 630 bar - Burst pressure: 1260 bar - Working temperature: From -25 °C to +110 °C - Compatibility with fluids: Mineral oils, Synthetic fluids - Degree protection: IP66 according to EN 60529 <p>Electrical data</p> <ul style="list-style-type: none"> - Electrical connection: Deutsch DT-04-3-P - Resistive load: 0.2 A / 115 Vdc - Switching type: SPDT contact - Thermal lockout: Normally open up to 30 °C (option "F")
Electrical Differential Indicator			
Settings	Ordering code		
1.2 bar ±10%	DE M 12 x x 35 P01		
2 bar ±10%	DE M 20 x x 35 P01		
			

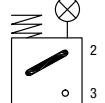
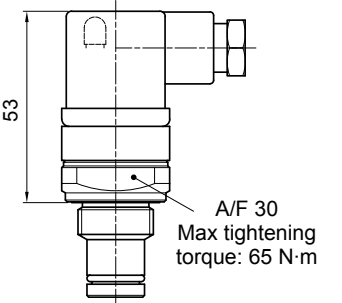
DLA*51 - DLA*52		<p>Hydraulic symbol</p> 	<p>Materials</p> <ul style="list-style-type: none"> - Body: Brass - Base: Transparent Nylon - Contacts: Silver - Seal: HNBR - FPM <p>Technical data</p> <ul style="list-style-type: none"> - Max working pressure: 420 bar - Proof pressure: 630 bar - Burst pressure: 1260 bar - Working temperature: From -25 °C to +110 °C - Compatibility with fluids: Mineral oils, Synthetic fluids - Degree protection: IP66 according to EN 60529 <p>Electrical data</p> <ul style="list-style-type: none"> - Electrical connection: EN 175301-803 - Type: 51 52 - Lamps: 24 Vdc 110 Vdc - Resistive load: 1 A / 24 Vdc 1 A / 110 Vdc
Electrical/Visual Differential Indicator			
Settings	Ordering code		
1.2 bar ±10%	DL A 12 x A xx P01		
2 bar ±10%	DL A 20 x A xx P01		
			

DLA*71	
Electrical/Visual Differential Indicator	
Settings	Ordering code
1.2 bar \pm 10%	DL A 12 x A 71 P01
2 bar \pm 10%	DL A 20 x A 71 P01

Hydraulic symbol

Electrical symbol

Materials

- Body: Brass
- Base: Black Nylon
- Contacts: Silver
- Seal: HNBR - FPM

Technical data

- Max working pressure: 420 bar
- Proof pressure: 630 bar
- Burst pressure: 1260 bar
- Working temperature: From -25 °C to +110 °C
- Compatibility with fluids: Mineral oils, Synthetic fluids
HFA, HFB, HFC according to ISO 2943
- Degree protection: IP65 according to EN 60529
IP69K according to ISO 20653

Electrical data

- Electrical connection: IEC 61076-2-101 D (M12)
- Lamps: 24 Vdc
- Resistive load: 0.4 A / 24 Vdc

DLE*A50	
Electrical/Visual Differential Indicator	
Settings	Ordering code
1.2 bar \pm 10%	DL E 12 x A 50 P01
2 bar \pm 10%	DL E 20 x A 50 P01

Hydraulic symbol

Electrical symbol

Materials

- Body: Brass
- Base: Black Nylon
- Contacts: Silver
- Seal: HNBR - FPM

Technical data

- Max working pressure: 420 bar
- Proof pressure: 630 bar
- Burst pressure: 1260 bar
- Working temperature: From -25 °C to +110 °C
- Compatibility with fluids: Mineral oils, Synthetic fluids
HFA, HFB, HFC according to ISO 2943
- Degree protection: IP65 according to EN 60529

Electrical data

- Electrical connections: EN 175301-803
- Resistive load: 5 A / 250 Vac
- Available the connector with lamps

DLE*F50	
Electrical/Visual Differential Indicator	
Settings	Ordering code
1.2 bar \pm 10%	DL E 12 x F 50 P01
2 bar \pm 10%	DL E 20 x F 50 P01

Hydraulic symbol

Electrical symbol

Materials

- Body: Brass
- Base: Black Nylon
- Contacts: Silver
- Seal: HNBR - FPM

Technical data

- Max working pressure: 420 bar
- Proof pressure: 630 bar
- Burst pressure: 1260 bar
- Working temperature: From -25 °C to +110 °C
- Compatibility with fluids: Mineral oils, Synthetic fluids
HFA, HFB, HFC according to ISO 2943
- Degree protection: IP65 according to EN 60529

Electrical data

- Electrical connections: EN 175301-803
- Resistive load: 5 A / 250 Vac
- Thermal lockout setting: +30 °C

DIFFERENTIAL INDICATORS

Dimensions

DTA*70	
Electronic Differential Indicator	
Settings	Ordering code
1.2 bar \pm 10%	DT A 12 x x 70 P01
2 bar \pm 10%	DT A 20 x x 70 P01

47

A/F 30
Max tightening torque: 50 N-m

Hydraulic symbol

Materials

- Body: Brass
- Internal parts: Brass - Nylon
- Contacts: Silver
- Seal: HNBR - FPM

Technical data

- Max working pressure: 420 bar
- Proof pressure: 630 bar
- Burst pressure: 1260 bar
- Compatibility with fluids: Mineral oils, Synthetic fluids
HFA, HFB, HFC according to ISO 2943
- Degree protection: IP67 according to EN 60529

Electrical data

- Electrical connection: IEC 61076-2-101 D (M12)
- Power supply: 24 Vdc
- Analogue output: From 4 to 20 mA
- Thermal lockout: 30 °C (all output signals stalled up to 30 °C)

Electrical symbol

①	○	○	+24 Vdc
②	○	○	4 ÷ 20 mA
③	○	○	75% - N.O. Digital output
④	○	○	100% - N.O. Digital output
⑤	○	○	0 Vdc

DVA	
Visual Differential Indicator	
Settings	Ordering code
1.2 bar \pm 10%	DV A 12 x P01
2 bar \pm 10%	DV A 20 x P01

39

Green / Red
clogging indicator

A/F 28
Max tightening torque: 65 N-m

Hydraulic symbol

Materials

- Body: Brass
- Internal parts: Brass - Nylon
- Contacts: Silver
- Seal: HNBR - FPM

Technical data

- Reset: Automatic reset
- Max working pressure: 420 bar
- Proof pressure: 630 bar
- Burst pressure: 1260 bar
- Working temperature: From -25 °C to +110 °C
- Compatibility with fluids: Mineral oils, Synthetic fluids
HFA, HFB, HFC according to ISO 2943
- Degree protection: IP65 according to EN 60529

DVM	
Visual Differential Indicator	
Settings	Ordering code
1.2 bar \pm 10%	DV M 12 x P01
2 bar \pm 10%	DV M 20 x P01

34

Red
clogging indicator

A/F 30
Max tightening torque: 65 N-m

Hydraulic symbol

Materials

- Body: Brass
- Internal parts: Brass - Nylon
- Contacts: Silver
- Seal: HNBR - FPM

Technical data

- Reset: Manual reset
- Max working pressure: 420 bar
- Proof pressure: 630 bar
- Burst pressure: 1260 bar
- Working temperature: From -25 °C to +110 °C
- Compatibility with fluids: Mineral oils, Synthetic fluids
HFA, HFB, HFC according to ISO 2943
- Degree protection: IP65 according to EN 60529

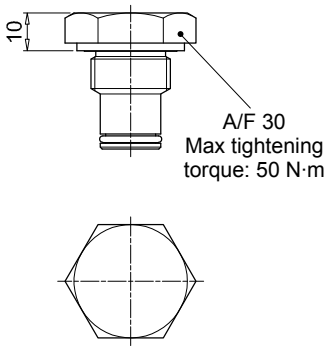
T2		Materials - Body: Phosphatized steel - Seal: HNBR / FPM				
Indicator plug						
<table border="1" style="width: 100%; border-collapse: collapse;"> <thead> <tr> <th style="width: 50%;">Seal</th> <th style="width: 50%;">Ordering code</th> </tr> </thead> <tbody> <tr> <td style="text-align: center;">HNBR</td> <td style="text-align: center;">T2 H</td> </tr> <tr> <td style="text-align: center;">FPM</td> <td style="text-align: center;">T2 V</td> </tr> </tbody> </table>	Seal		Ordering code	HNBR	T2 H	FPM
Seal	Ordering code					
HNBR	T2 H					
FPM	T2 V					
						

DESIGNATION & ORDERING CODE - DIFFERENTIAL INDICATORS									
Series		Configuration example 1: DE M 12 H F 50 P01							
DE Electrical differential indicator		Configuration example 2: DL E 20 V A 71 P01							
DL Electrical/Visual differential indicator		Configuration example 3: DT A 12 H F 70 P01							
DT Electronic differential indicator		Configuration example 4: DV M 20 V P01							
DV Visual differential indicator									
Type	DE	DL	DT	DV					
A Standard type	•	•	•	A With automatic reset					
M With wired electrical connection	•			M With manual reset					
E For high power supply		•							
Pressure setting									
12 1.2 bar									
20 2 bar									
Seals									
H HNBR									
V FPM									
Thermostat		DEA	DEM	DLA	DLE	DT	DV		
A Without		•	•	•	•				
F With thermostat			•		•	•			
Electrical connections		DEA	DEM	DLA	DLE	DT	DV		
10 Connection AMP Superseal series 1.5			•						
20 Connection AMP Timer Junior			•						
30 Connection Deutsch DT-04-2-P			•						
35 Connection Deutsch DT-04-3-P			•						
50 Connection EN 175301-803		•			•				
51 Connection EN 175301-803, transparent base with lamps 24 Vdc					•				
52 Connection EN 175301-803, transparent base with lamps 110 Vdc					•				
70 Connection IEC 61076-2-101 D (M12)						•			
71 Connection IEC 61076-2-101 D (M12), black base with lamps 24 Vdc					•				
		Option							
		P01 MP Filtri standard							
		Pxx Customized							

DESIGNATION & ORDERING CODE - DIFFERENTIAL INDICATOR PLUG		
Series		Configuration example T2 H
T2 Indicator plug		
Seals		
H HNBR		
V FPM		

Clogging indicators are devices that check the life time of the filter elements. They measure the pressure drop through the filter element directly connected to the filter housing.

These devices trip when the clogging of the filter element causes a pressure drop increasing across the filter element.

Filter elements are efficient only if their Dirt Holding Capacity is fully exploited.

This is achieved by using filter housings equipped with clogging indicators.

The indicator is set to alarm before the element becomes fully clogged.

MP Filtri can supply indicators of the following designs:

- Vacuum switches and gauges
- Pressure switches and gauges
- Differential pressure indicators

These type of devices can be provided with a visual, electrical or both signals.

The electronic differential pressure clogging indicator is also available.

It provides both analogical 4-20 mA output and digital warning (75% of clogging) and alarm (clogging) outputs.

Clogging Indicators



Clogging indicators



Suitable indicator types

VACUUM INDICATORS

Vacuum indicators are used on the Suction line to check the efficiency of the filter element.

They measure the pressure downstream of the filter element.

Standard items are produced with R 1/4" EN 10226 connection.

Available products with R 1/8" EN 10226 to be fitted on MPS series.

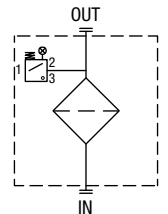
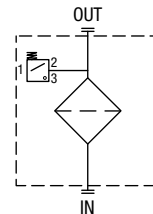
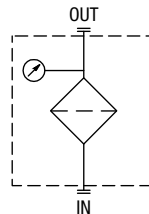

BAROMETRIC INDICATORS

Pressure indicators are used on the Return line to check the efficiency of the filter element.

They measure the pressure upstream of the filter element.

Standard items are produced with R 1/8" EN 10226 connection.

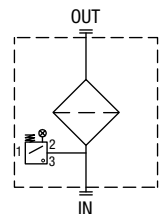
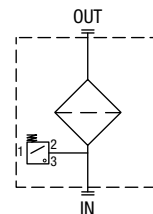
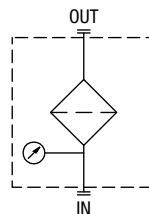

DIFFERENTIAL INDICATORS

Differential indicators are used on the Pressure line to check the efficiency of the filter element.

They measure the pressure upstream and downstream of the filter element (differential pressure).

Standard items are produced with special connection G 1/2" size.

Also available in Stainless Steel models.

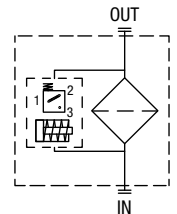
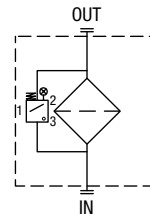
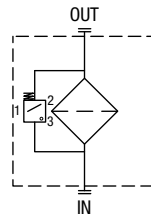
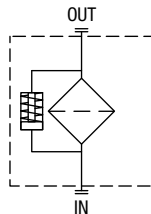

Filter family	Filter series	Visual indicator	Electrical indicator	Electrical / Visual indicator	Electronic indicator
SUCTION FILTERS	SF2 250 - 350 SF2 500 - 501 - 503 - 504 - 505 SF2 510 - 535 - 540	WA16P01 VVR16P01	VEA21AA50P01	VLA21AA51P01 VLA21AA52P01 VLA21AA53P01 VLA21AA71P01	
RETURN FILTERS	MPFX-MPTX-MPF-MPT with bypass 1.75 bar MPH with bypass 1.75 bar	BVA14P01 BVR14P01 BVP20HP01 BVQ20HP01	BEA15HA50P01 BEM15HA41P01	BLA15HA51P01 BLA15HA52P01 BLA15HA53P01 BLA15HA71P01	
	MPFX-MPTX-MPF-MPT with bypass 3 bar MPH with bypass 2.5 bar FRI 255	BVA25P01 BVR25P01 BVP20HP01 BVQ20HP01	BEA20HA50P01 BEM20HA41P01	BLA20HA51P01 BLA20HA52P01 BLA20HA53P01 BLA20HA71P01	
	MPLX FRI 025 - 040 - 100 - 250 - 630 - 850	DVA20xP01 DVM20xP01	DEA20xA50P01 DEM20xAxxP01	DLA20xA51P01 DLA20xA52P01 DLA20xA71P01 DLE20xA50P01 DLE20xF50P01	DTA20xF70P01
RETURN / SUCTION FILTERS	Suction line MRSX 116 - 165 - 166	WB16P01 VVS16P01	VEB21AA50P01	VLB21AA51P01 VLB21AA52P01 VLB21AA53P01 VLB21AA71P01	
	Return line MRSX 116 - 165 - 166 LMP 124 MULTIPOINT	BVA25P01 BVR25P01 BVP20HP01 BVQ20HP01	BEA25HA50P01 BEM25HA41P01 BET25HF10P01 BET25HF30P01 BET25HF50P01	BLA25HA51P01 BLA25HA52P01 BLA25HA53P01 BLA25HA71P01	
SPIN-ON FILTERS	Suction line MPS 050 - 070 - 100 - 150 MPS 200 - 250 - 300 - 350	VVB16P01 VVS16P01	VEB21AA50P01	VLB21AA51P01 VLB21AA52P01 VLB21AA53P01 VLB21AA71P01	
	Return line MPS 050 - 070 - 100 - 150 MPS 200 - 250 - 300 - 350	BVA14P01 BVR14P01 BVP20HP01 BVQ20HP01	BEA15HA50P01 BEM15HA41P01	BLA15HA51P01 BLA15HA52P01 BLA15HA53P01 BLA15HA71P01	
	In-line MPS 051 - 071 - 101 - 151 MPS 301 - 351 MSH 050 - 070 - 100 - 150	DVA12xP01 DVM12xP01	DEA12xA50P01 DEM12xAxxP01	DLA12xA51P01 DLA12xA52P01 DLA12xA71P01 DLE12xA50P01 DLE12xF50P01	
LOW & MEDIUM PRESSURE FILTERS	With bypass valve LMP 110 - 112 - 116 - 118 - 119 MULTIPOINT LMP 120 - 122 - 123 MULTIPOINT LMP 210 - 211 - LDP LMP 400 - 401 & 430 - 431 LMP 900 - 901 LMP 902 - 903 LMP 950 - 951 LMP 952 - 953 - 954 LMD 211 - 400 - 401 - 431 - 951 - LDD	DVA20xP01 DVM20xP01	DEA20xA50P01 DEM20xAxxP01	DLA20xA51P01 DLA20xA52P01 DLA20xA71P01 DLE20xA50P01 DLE20xF50P01	DTA20xF70P01
	Without bypass valve LMP 110 - 112 - 116 - 118 - 119 MULTIPOINT LMP 120 - 122 - 123 MULTIPOINT LMP 210 - 211 - LDP LMP 400 - 401 & 430 - 431 LMP 900 - 901 LMP 902 - 903 LMP 950 - 951 LMP 952 - 953 - 954 LMD 211 - 400 - 401 - 431 - 951 - LDD	DVA50xP01 DVM50xP01	DEA50xA50P01 DEM50xAxxP01	DLA50xA51P01 DLA50xA52P01 DLA50xA71P01 DLE50xA50P01 DLE50xF50P01	DTA50xF70P01
HIGH PRESSURE FILTERS	With bypass valve FMP 039 - 065 - 135 - 320 FHP 010 - 011 - 065 - 135 - 320 - 500 FMM 050 - 150 FHA 051 FHM 006 - 007 - 010 - 050 - 065 - 135 - 320 - 500 FHB 050 - 135 - 320 FHF 325 FHD 021 - 051 - 326 - 333	DVA50xP01 DVM50xP01	DEA50xA50P01 DEM50xAxxP01	DLA50xA51P01 DLA50xA52P01 DLA50xA71P01 DLE50xA50P01 DLE50xF50P01	DEH50xA48P01 DEH50xA49P01 DEH50xA70P01 DEH70xA48P01 DEH70xA49P01 DEH70xA70P01
	Without bypass valve FMP 039 - 065 - 135 - 320 FHP 010 - 011 - 065 - 135 - 320 - 500 FMM 050 - 150 FHA 051 FHM 006 - 007 - 010 - 050 - 065 - 135 - 320 - 500 FHB 050 - 135 - 320 FHF 325 FHD 021 - 051 - 326 - 333	DVA70xP01 DVM70xP01	DEA70xA50P01 DEM70xAxxP01	DLA70xA51P01 DLA70xA52P01 DLA70xA71P01 DLE70xA50P01 DLE70xF50P01	DEH50xA48P01 DEH50xA49P01 DEH50xA70P01 DEH70xA48P01 DEH70xA49P01 DEH70xA70P01
STAINLESS STEEL HIGH PRESSURE FILTERS	With bypass valve FZH 010 - 011 - 039 FZP 039 - 136 FZX 011 FZB 039 FZM 039 FZD 051	DVX50xP01 DVY50xP01	DEX50xA50P01	DLX50xA51P01 DLX50xA52P01	DEH50xA48P01 DEH50xA49P01 DEH50xA70P01 DEH70xA48P01 DEH70xA49P01 DEH70xA70P01
	Without bypass valve FZH 010 - 011 - 039 FZP 039 - 136 FZB 039 FZM 039 FZD 010 - 021 - 051	DVX70xP01 DVY70xP01	DEX70xA50P01	DLX70xA51P01 DLX70xA52P01	DEH50xA48P01 DEH50xA49P01 DEH50xA70P01 DEH70xA48P01 DEH70xA49P01 DEH70xA70P01

Hazardous area electronic indicator

NEW

All data, details and words contained in this publication are provided for information purposes only.
MP Filtri reserves the right to make modifications to the models and versions of the described products at any time
for both technical and / or commercial reasons.
The colors and the pictures of the products are purely indicative.
Any reproduction, partial or total, of this document is strictly forbidden.
All rights are strictly reserved.



WORLDWIDE NETWORK

HEADQUARTERS

MP Filtri S.p.A.
Via 1° Maggio, 3
20060 Pessano con Bornago
Milano - Italy

BRANCH OFFICES

MP Filtri U.K. Ltd.
Bourton Industrial Park
Bourton on the Water
GL54-2HQ Gloucestershire

MP Filtri Canada Inc.
8831 Keele Street
Concord, Ontario
L4K 2N1 - Canada

MP Filtri Germany GmbH
Hans-Wilhelmi-Straße
DE-66386 St. Ingbert

ITALFILTRI LLC
Russian Federation
Yurievsky Pereulok 13 a, Building 1
111020 Moscow - Russia

MP Filtri France SAS
Parc d'activités des Chanteraines
8 rue du Commandant d'Estienne d'Orves
Immeuble D3
92390 Villeneuve la Garenne

MP Filtri (Shanghai) Co., Ltd.
1280 Lianxi Road, Bld 8 - 2nd Floor
Shanghai - Pudong
201204 China

MP Filtri U.S.A. Inc.
2055 Quaker Pointe Drive
Quakertown, PA 18951

MP Filtri India Pvt. Ltd.
Plot-7F, Raj Pinnacle,
Beside RMZ Centennial
Brookefield Road, Whitefield
560048 Bangalore

PASSION TO PERFORM



mpfiltri.com